



BDV60 Blowdown Vessels

Description

BDV60 blowdown vessels are **CE** marked and comply with the Pressure Equipment Directive (PED).

They also comply with Blowdown Systems, Guidance for Industrial Steam Boilers (Ref: BG03), for the construction of vessels used in boiler blowdown applications, issued by the Health and Safety Executive.

BDV60 blowdown vessels are designed to accept discharges from:

- Manual/automatically controlled bottom blowdown.
- Automatic TDS blowdown control valves and systems.
- Controlled bleed valves for continuous blowdown.
- Level control chambers and level gauge glasses.
- Heat recovery equipment.

Design and construction

Design code	ASME VIII DIV 1 2015		
Material	Carbon steel		
Connection	Standard	EN 1092	PN16 flanges
	Optional	ASME B16.5	ASME Class 150 and ASME Class 300 flanges
Paint finish	Temperature resistant silver paint		

Associated equipment

- VH vent head
- M21S2 ball valve
- DCV2 check valves
- Pressure gauge and 'U' syphon
- Vessel drain valve
- Cooling water system

For further details please refer to the appropriate literature.

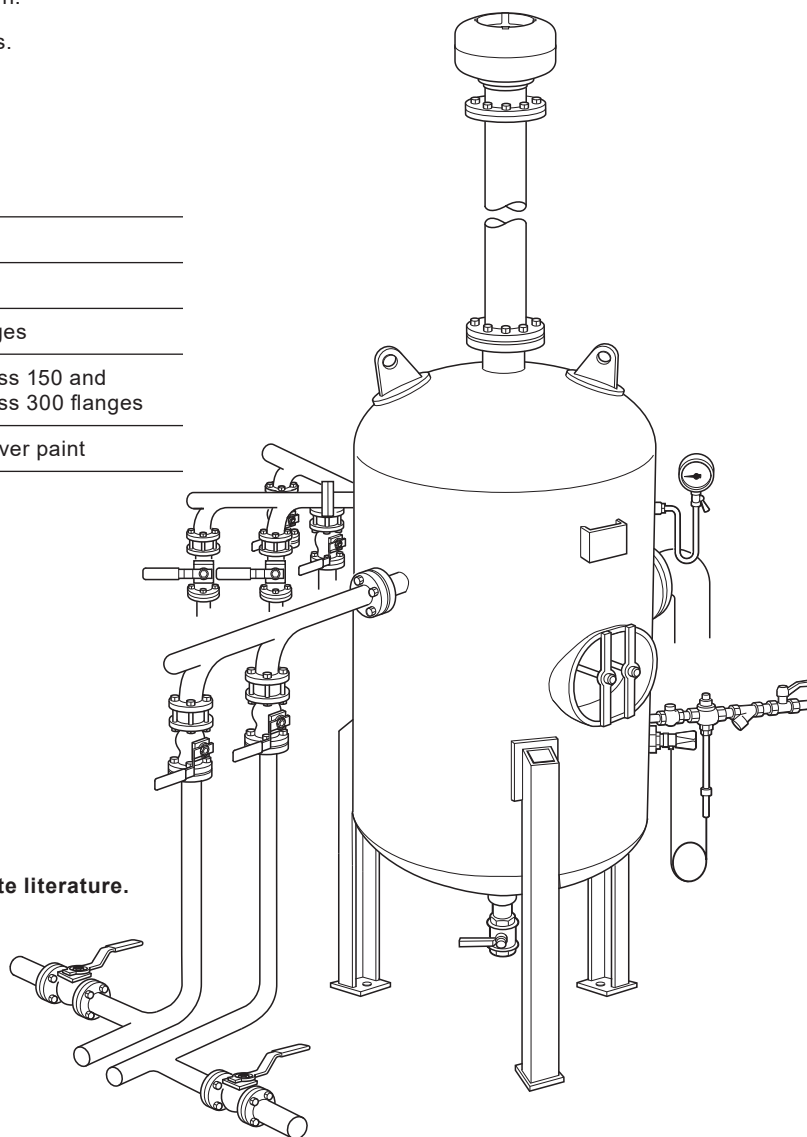

Materials

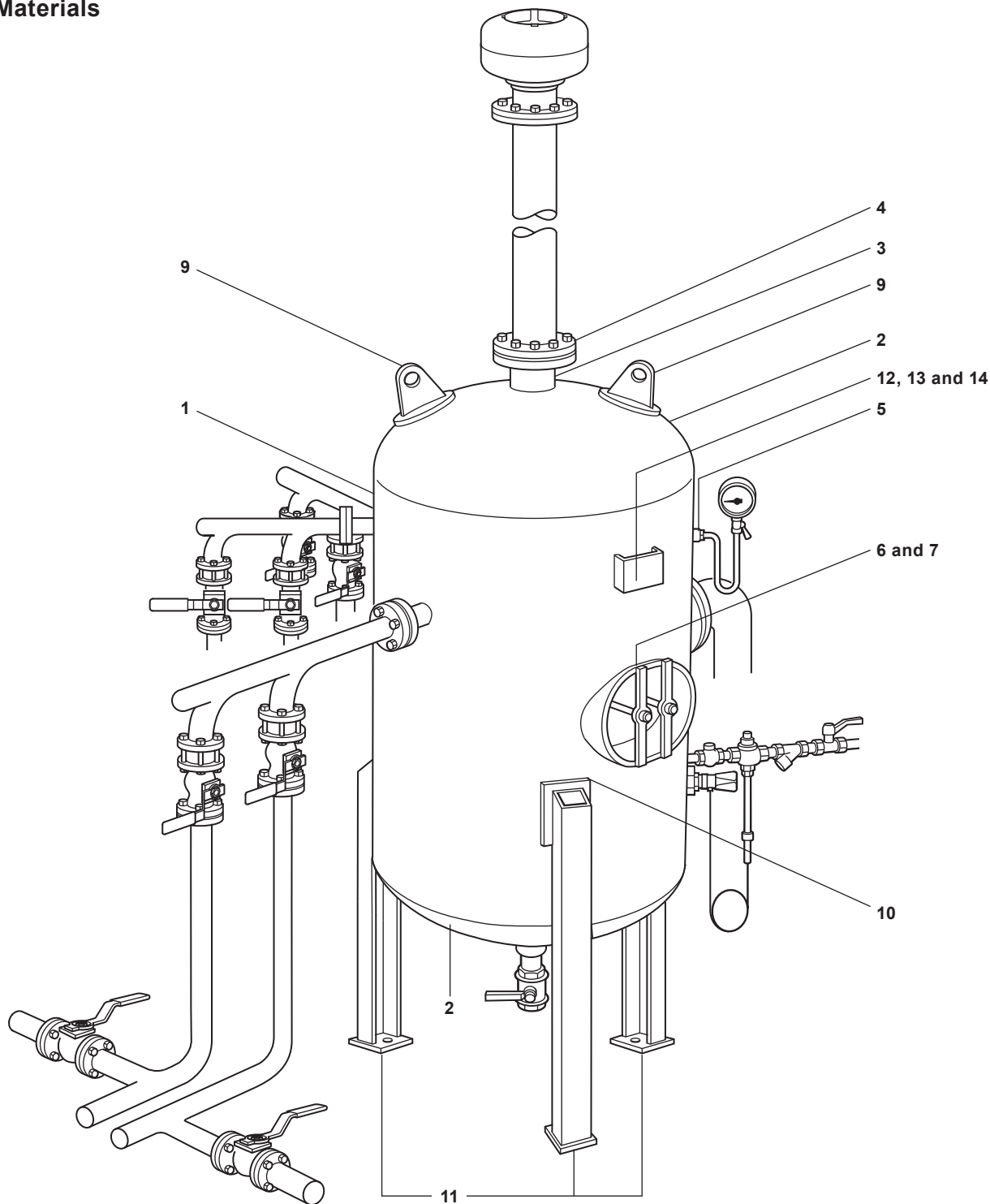

No.	Part	Material
1	Shell cylinder	BS EN 10028-2 P265GH
2	Dished ends	BS EN 10028-2 P265GH
3	Nozzle, pipe	ASTM A333 Gr.6
4	Nozzle, flange	A105N
5	Nozzle, coupling	ASTM A350 LF2
6	Inspection opening	BS EN 10028-2 P265GH
7	Inspection opening gasket	Rubber, NR/SBR
8	Impingement plate	ASTM A240, 304

No.	Part	Material
9	Lifting lug	BS EN 10028-2 P265GH
10	Wrapper plate	BS EN 10028-2 P265GH
11	Support leg/foot	BS EN 10025 S275
12	Nameplate stand-off	BS EN 10028-2 P265GH
13	Nameplate bracket	BS EN 10025 S275
14	Nameplate	Aluminium
15	Long radius butt weld elbow (Internal)	ASTM A420 WPL6

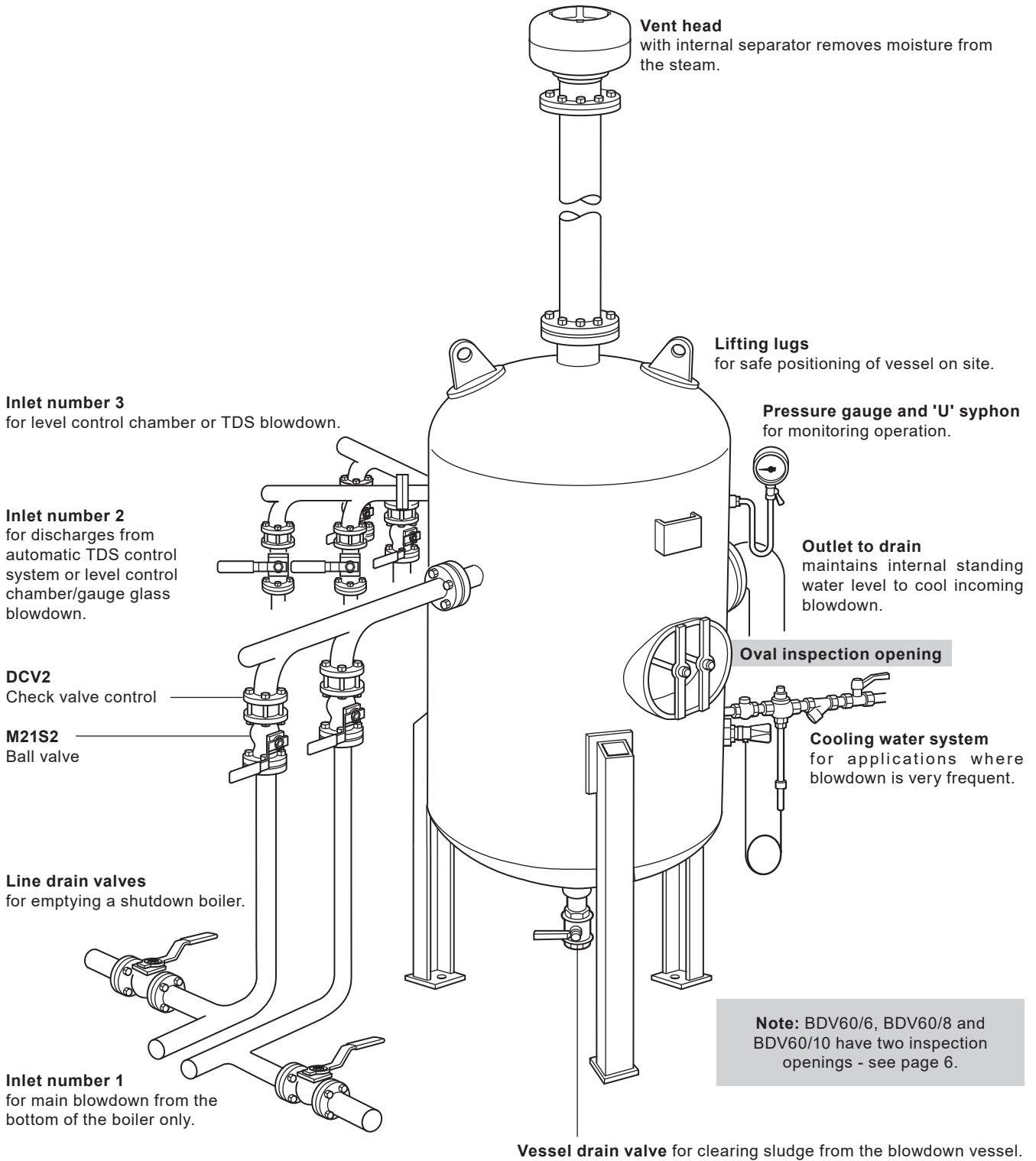

This is only a representation of a possible set-up, the product may have 3 or 4 legs and the inspection port may be different on the product.

Sizing and selection

The selection of a blowdown vessel depends on the flowrate and the proportion of flash steam released.

The following factors affect the selection:

- The boiler pressure.
- The number of boilers.
- The duration of blowdown.
- The blowdown line size.
- The length of blowdown line between the boiler and the blowdown vessel.
- The blowdown regime.

For example the sizing below assumes the blowdown line has an 'equivalent straight length' of at least 7 m.

When estimating 'equivalent straight length' the lengths shown in **Table 1** should be added to the length of straight pipe to allow for valves and fittings.

From **Table 1** it will be seen that in most practical applications it would be unusual for the equivalent straight length to be less than 7 m.

If the length is less than 7 m multiply the actual boiler pressure by 1.15 before using the sizing table, **Table 2**.

The blowdown regime:

- Typical normal bottom blowdown of, perhaps, 5 seconds duration.
- Weekly low level alarm testing where practice is in accordance with BG01 and INDG436 - steam down from normal level to first low water level and blow down from first to second low water level.
- Blowdown discharges from sequencing valves on external chambers, gauge glasses etc.
- Automatic TDS control discharges.

The selection table (Table 2) only applies if the blowdown duration is no longer than 20 seconds in total, starting with a cold vessel (water at a temperature of 15 °C to 20 °C).

If this time is exceeded, carryover of water with the flash steam may occur through the vent. The water may also be too hot to discharge safely and legally into a public drainage system.

Always incorporate a cooling water system for multi-boiler applications or in instances where the frequency or duration of blowdown is considerably in excess of the requirements stated in Blowdown Systems, Guidance for Industrial Steam Boilers (Ref: BG03), BG01 and INDG436.

If there is any doubt about correct vessel selection, please contact Spirax Sarco outlining the specific conditions and blowdown regime.

Table 1 Equivalent straight lengths

Blowdown line size	25 mm (1")	32 mm (1¼")	40 mm (1½")	50 mm (2")
Pipe fitting or valve	Equivalent length in metres			
Long radius bend	0.5	0.7	0.8	0.9
Manifold inlet	1.1	1.5	1.7	2.2
Globe valve	9.6	12.2	13.9	17.8
Check valve	3.6	4.3	5.0	6.3
Blowdown valve	0.3	0.4	0.4	0.5

Table 2 Blowdown vessel selection

Blowdown line size	25 mm (1")		32 mm (1¼")		40 mm (1½")		50 mm (2")	
	Boiler pressure bar g	psi g	Blowdown vessel BDV60/_					
	5.5	80	3	3	3	4		
	7.6	110	3	3	4	5		
	8.3	120	3	4	4	6		
	10.3	150	3	4	5	6		
	12.1	175	4	4	5	8		
	17.2	250	4	5	6	8		
	20.7	300	5	6	8	10		
	24.1	350	5	6	8	10		
	27.6	400	6	8	8	-		

Note: For intermediate pressures go to the next higher pressure.

Table 1 Equivalent straight lengths

Blowdown line size	25 mm (1")	32 mm (1¼")	40 mm (1½")	50 mm (2")
Pipe fitting or valve	Equivalent length in metres			
Long radius bend	0.5	0.7	0.8	0.9
Manifold inlet	1.1	1.5	1.7	2.2
Globe valve	9.6	12.2	13.9	17.8
Check valve	3.6	4.3	5.0	6.3
Blowdown valve	0.3	0.4	0.4	0.5

Table 2 Blowdown vessel selection

Blowdown line size	25 mm (1")	32 mm (1¼")	40 mm (1½")	50 mm (2")	
Boiler pressure bar g	Blowdown vessel BDV60/_				
psi g					
5.5	80	3	3	3	4
7.6	110	3	3	4	5
8.3	120	3	4	4	6
10.3	150	3	4	5	6
12.1	175	4	4	5	8
17.2	250	4	5	6	8
20.7	300	5	6	8	10
24.1	350	5	6	8	10
27.6	400	6	8	8	-

Note: For intermediate pressures go to the next higher pressure.

Table 3 Vent head selection

Note: The vent head required depends on the vessel selected

For a **BDV60/3** select a **VH4** vent head

For a **BDV60/4** select a **VH4** vent head

For a **BDV60/5** select a **VH6** vent head

For a **BDV60/6** select a **VH6** vent head

For a **BDV60/8** select a **VH8** vent head

For a **BDV60/10** select a **VH8** vent head

Graph 1 Blowdown flowrates

This graph will give the flowrate of blowdown in litres per second. When this value has been read, multiply it by the duration of blowdown (seconds), and the answer will be the maximum volume discharged.

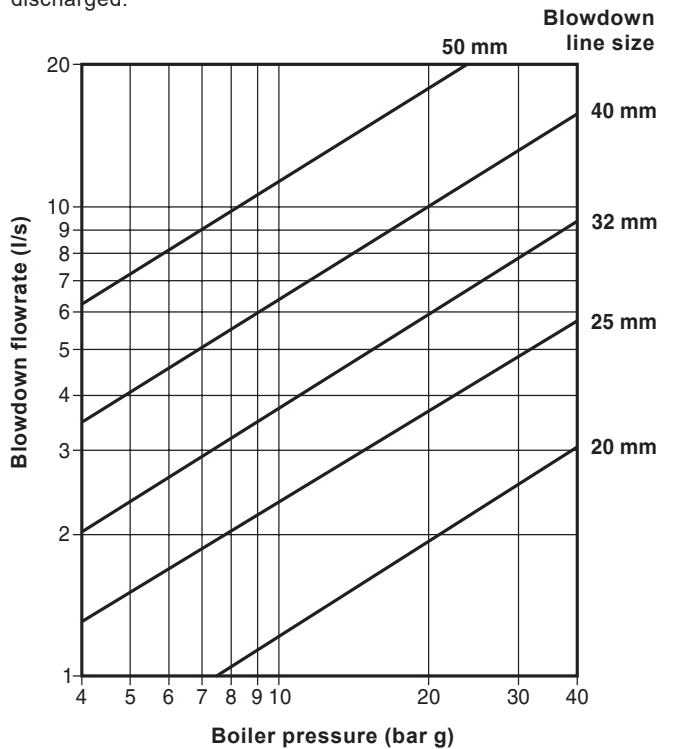

How to select the blowdown vessel:

- Step 1.** With the aid of **Table 1**, determine the equivalent straight length of the blowdown line.
- Step 2.** Use **Table 2** to initially establish the correct size of vessel. Note that if the result of Step 1 is less than 7 m, multiple the boiler pressure by 1.15.
If the vessel is to be used in the conditions set out above, then continue to Step 4.
- Step 3.** Using **Table 4** which contains the vessel data, establish the volume of standing water in the selected vessel. This volume should be at least **twice** that of the maximum volume of blowdown. The maximum volume of blowdown is usually the volume discharged when blowing down from 1st low level to 2nd low level alarm. If this volume is unknown, it can be calculated with the aid of **Graph 1**, where details on its use are given.
If it is determined that the volume of standing water is insufficient, then a larger blowdown vessel must be selected in order to satisfy this requirement.
- Step 4.** With the aid of **Table 3**, the correct vent head can be selected to suit the vessel.

The selection is now complete.

Selection example:

For a 10 bar g boiler with 40 mm blowdown line at least 7 m long select, from **Table 2**, a **BDV60/5**.
From **Table 3** select a **VH6** vent head.

Table 4 Sizes, pipe connections, dimensions, weights and capacities (approximate) in mm, kg and L

Blowdown vessel type		BDV60/3	BDV60/4	BDV60/5	BDV60/6	BDV60/8	BDV60/10	
Sizes, pipe connections and dimensions	A Flanged PN16*	100	100	150	150	200	200	
	B Flanged PN16*	80	80	100	100	150	150	
	C Oval Inspection opening	Height (Internal)	100	100	100	100	100	100
		Width (Internal)	150	150	150	150	150	150
	D	460	610	765	915	1205	1500	
	E	400	400	400	400	400	400	
	F	500	540	580	630	705	770	
	G	310	350	390	440	525	590	
	H	1830	1910	1995	2095	2240	2370	
	J	1080	1125	1165	1215	1290	1355	
	K	330	405	485	560	705	850	
	X	1080	1120	1163	1568	1612	1676	
Y	-	-	-	864	962	1026		
Number of legs		3	3	3	3	4	4	
Weights	Empty	185	220	275	392	630	910	
	Full (e.g. for hydraulic test)	376	580	861	1267	2252	3610	
Capacities - standing water		96	180	293	437	811	1350	

* Note: Flanged ASME B16.5 Class 150 and 300 connections are available at extra cost. For further details contact Spirax Sarco.

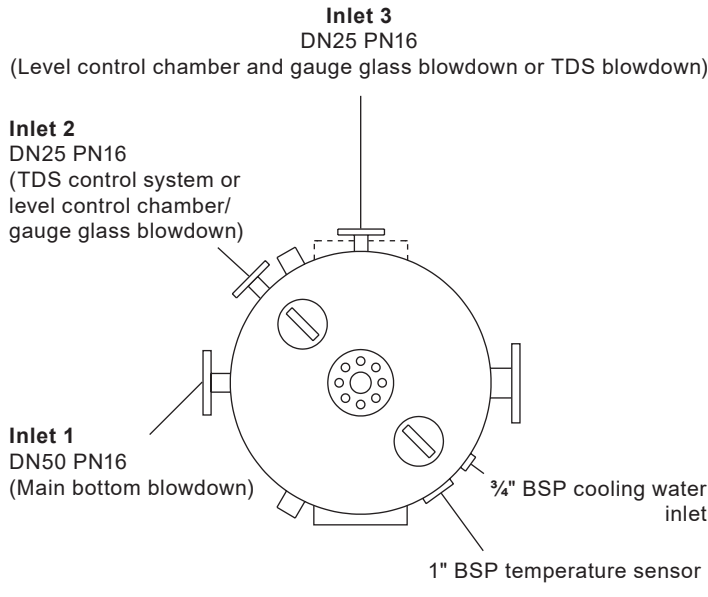
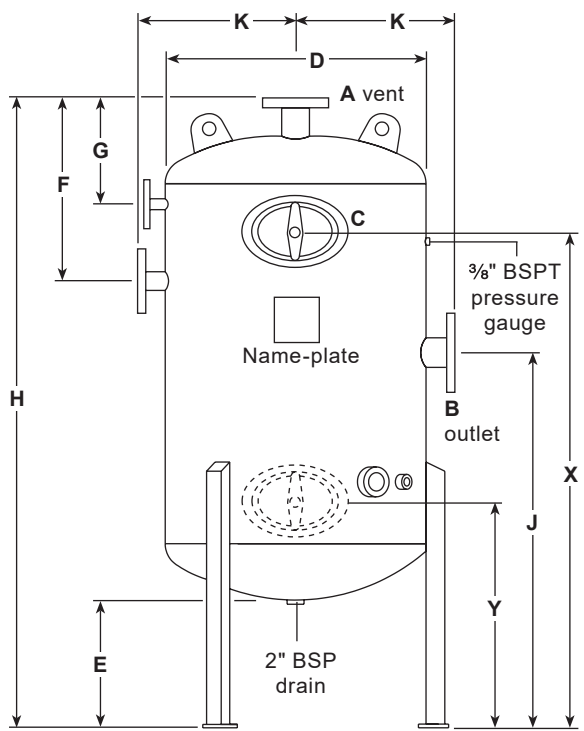

This is only a representation of a possible set-up, the product may have 3 or 4 legs and the inspection port may be different on the product.

How to order

Example: 1 off Spirax Sarco BDV60/5 blowdown vessel and a VH6 vent head to suit a 10 bar g boiler having a 40 mm blowdown line.

Pressure/temperature limits

Please note:

For the application of boiler blowdown and to comply with the HSE Guidance Note Blowdown Systems, Guidance for Industrial Steam Boilers (Ref: BG03) the vessel internal pressure should not exceed 0.35 bar g.

Body design conditions	PN16
Maximum design pressure	7 bar g @ 171 °C
Maximum design temperature	171 °C @ 7 bar g
Minimum design temperature	-10 °C
Maximum operating pressure re. Blowdown Systems, Guidance or Industrial Steam Boilers (Ref: BG03)	0.35 bar g
Maximum operating temperature re. Blowdown Systems, Guidance for Industrial Steam Boilers (Ref: BG03)	109 °C
Minimum operating temperature	0 °C
Designed for a maximum cold hydraulic test pressure of	11 bar g

Safety information, installation and maintenance

For full details see the Installation and Maintenance Instructions supplied with the product.

Maintenance note:

The vessel must be drained every six months to remove concentrated blowdown water/sludge. Before reusing, the vessel must be refilled with fresh water.

Blowdown vessels should be thoroughly examined by a 'competent person' every 14 months or at every major boiler inspection.

Spare parts:

New gaskets for the inspection openings are available as spares from Spirax Sarco.

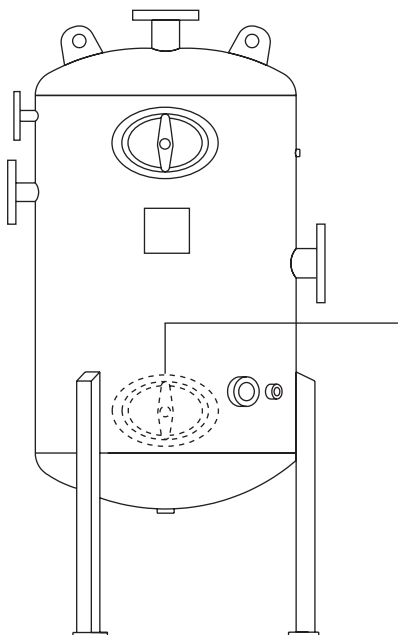

Note: There is a second inspection opening on the BDV60/6, BDV60/8 and BDV60/10 which is fitted 180° to the top opening. Other sizes have a single central opening, similar to the one shown on page 2.