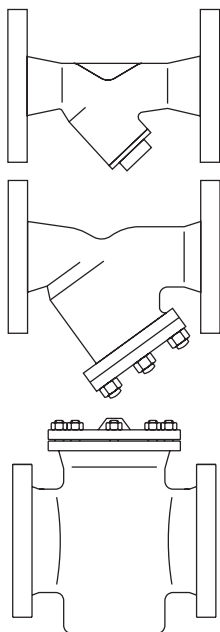

Fig 3, 7, 33, 34, 34HP, 36, 3616, 37 and Fig 3716
Flanged Strainers
Installation and Maintenance Instructions



1. *Safety information*
2. *General product information*
3. *Installation*
4. *Commissioning*
5. *Operation*
6. *Fault finding*
7. *Maintenance*
8. *Spare parts*

1. Safety information

Safe operation of these products can only be guaranteed if they are properly installed, commissioned, used and maintained by qualified personnel (see Section 1.11) in compliance with the operating instructions. General installation and safety instructions for pipeline and plant construction, as well as the proper use of tools and safety equipment must also be complied with.

1.1 Intended use

Referring to the Installation and Maintenance Instructions, name-plate and Technical Information Sheet, check that the product is suitable for the intended use/application. The products listed below comply with the requirements of the European Pressure Equipment Directive 97/23/EC and carry the **CE** mark when so required. The products fall within the following Pressure Equipment Directive categories:

Product		Group 1 Gases	Group 2 Gases	Group 1 Liquids	Group 2 Liquids
Fig 3	DN15 - DN25	SEP	SEP	SEP	SEP
	DN32 - DN40	1	SEP	SEP	SEP
	DN50 - DN80	2	1	SEP	SEP
	DN100	2	1	2	SEP
Fig 7	DN200 - DN250	3	2	2	SEP
Fig 34 (ASME / ANSI 150)	DN15 - DN25	SEP	SEP	SEP	SEP
	DN32	2	SEP	SEP	SEP
	DN40 - DN50	2	1	SEP	SEP
	DN65 - DN100	2	1	2	SEP
	DN125 - DN150	3	2	2	SEP
	DN200	-	2	2	SEP
Fig 34 (ASME / ANSI 300)	DN15 - DN25	SEP	SEP	SEP	SEP
	DN32	2	SEP	SEP	SEP
	DN40 - DN50	2	1	SEP	SEP
	DN65 - DN100	2	1	2	SEP
	DN125 - DN150	3	2	2	SEP
	DN200	-	3	2	SEP
Fig 34 (DIN)	DN15 - DN25	SEP	SEP	SEP	SEP
	DN32	2	SEP	SEP	SEP
	DN40 - DN50	2	1	SEP	SEP
	DN65 - DN100	2	1	2	SEP
	DN125 - DN150	3	2	2	SEP
	DN200	-	3	2	SEP
Fig 34 (JIS / KS 20)	DN15 - DN25	SEP	SEP	SEP	SEP
	DN32	2	SEP	SEP	SEP
	DN40 - DN50	2	1	SEP	SEP
	DN65 - DN100	2	1	2	SEP
	DN125 - DN150	3	2	2	SEP
	DN200	-	2	2	SEP

Product		Group 1 Gases	Group 2 Gases	Group 1 Liquids	Group 2 Liquids
Fig 34HP	DN15 - DN20	SEP	SEP	SEP	SEP
	DN25 - DN50	2	SEP	2	SEP
	DN65 - DN100	3	2	2	SEP
	DN150 - DN200	4	3	2	SEP
Fig 37 (JIS / KS 20)	DN15 - DN25	SEP	SEP	SEP	SEP
	DN32	2	SEP	SEP	SEP
	DN40 - DN50	2	1	SEP	SEP
	DN65 - DN100	2	1	2	SEP
	DN125 - DN150	3	2	2	SEP
	DN200	3	2	2	SEP
Fig 33	DN15 - DN25	SEP	SEP	SEP	SEP
	DN32 - DN50	1	SEP	SEP	SEP
Fig 3616 (DIN)	DN65 - DN125	2	1	SEP	SEP
	DN150 - DN200	2	1	2	SEP
	DN15 - DN25	SEP	SEP	SEP	SEP
Fig 3616 (ASTM)	DN32 - DN50	1	SEP	SEP	SEP
	DN65 - DN100	2	1	SEP	SEP
	DN125 - DN150	2	1	2	SEP
	DN15 - DN25	SEP	SEP	SEP	SEP
Fig 3716 (DIN)	DN32 - DN50	1	SEP	SEP	SEP
	DN65 - DN125	2	SEP	1	SEP
	DN150 - DN200	3	2	2	SEP

- i) The products have been specifically designed for use on propane or methane gases which are in Group 1 of the above mentioned Pressure Equipment Directive. They can also be used on steam, air or water/condensate which are in Group 2 of the Pressure Equipment Directive. The products' use on other fluids may be possible but, if this is contemplated, Spirax Sarco should be contacted to confirm the suitability of the product for the application being considered.
- ii) Check material suitability, pressure and temperature and their maximum and minimum values. If the maximum operating limits of the product are lower than those of the system in which it is being fitted, or if malfunction of the product could result in a dangerous overpressure or overtemperature occurrence, ensure a safety device is included in the system to prevent such over-limit situations.
- iii) Determine the correct installation situation and direction of fluid flow.
- iv) Spirax Sarco products are not intended to withstand external stresses that may be induced by any system to which they are fitted. It is the responsibility of the installer to consider these stresses and take adequate precautions to minimise them.
- v) Remove protection covers from all connections and protective film from all nameplates, where appropriate, before installation on steam or other high temperature applications.

1.2 Access

Ensure safe access and if necessary a safe working platform (suitably guarded) before attempting to work on the product. Arrange suitable lifting gear if required.

1.3 Lighting

Ensure adequate lighting, particularly where detailed or intricate work is required.

1.4 Hazardous liquids or gases in the pipeline

Consider what is in the pipeline or what may have been in the pipeline at some previous time. Consider: flammable materials, substances hazardous to health, extremes of temperature.

1.5 Hazardous environment around the product

Consider: explosion risk areas, lack of oxygen (e.g. tanks, pits), dangerous gases, extremes of temperature, hot surfaces, fire hazard (e.g. during welding), excessive noise, moving machinery.

1.6 The system

Consider the effect on the complete system of the work proposed. Will any proposed action (e.g. closing isolation valves, electrical isolation) put any other part of the system or any personnel at risk?

Dangers might include isolation of vents or protective devices or the rendering ineffective of controls or alarms. Ensure isolation valves are turned on and off in a gradual way to avoid system shocks.

1.7 Pressure systems

Ensure that any pressure is isolated and safely vented to atmospheric pressure. Consider double isolation (double block and bleed) and the locking or labelling of closed valves. Do not assume that the system has depressurised even when the pressure gauge indicates zero.

1.8 Temperature

Allow time for temperature to normalise after isolation to avoid danger of burns.

1.9 Tools and consumables

Before starting work ensure that you have suitable tools and/or consumables available. Use only genuine Spirax Sarco replacement parts.

1.10 Protective clothing

Consider whether you and/or others in the vicinity require any protective clothing to protect against the hazards of, for example, chemicals, high/low temperature, radiation, noise, falling objects, and dangers to eyes and face.

1.11 Permits to work

All work must be carried out or be supervised by a suitably competent person. Installation and operating personnel should be trained in the correct use of the product according to the Installation and Maintenance Instructions.

Where a formal 'permit to work' system is in force it must be complied with. Where there is no such system, it is recommended that a responsible person should know what work is going on and, where necessary, arrange to have an assistant whose primary responsibility is safety.

Post 'warning notices' if necessary.

1.12 Handling

Manual handling of large and/or heavy products may present a risk of injury. Lifting, pushing, pulling, carrying or supporting a load by bodily force can cause injury particularly to the back. You are advised to assess the risks taking into account the task, the individual, the load and the working environment and use the appropriate handling method depending on the circumstances of the work being done.

1.13 Residual hazards

In normal use the external surface of the product may be very hot. If used at the maximum permitted operating conditions the surface temperature of some products may reach temperatures of 400°C (752°F).

Many products are not self-draining. Take due care when dismantling or removing the product from an installation (refer to 'Maintenance instructions').

1.14 Freezing

Provision must be made to protect products which are not self-draining against frost damage in environments where they may be exposed to temperatures below freezing point.

1.15 Disposal

Unless otherwise stated in the Installation and Maintenance Instructions, this product is recyclable and no ecological hazard is anticipated with its disposal providing due care is taken.

1.16 Returning products

Customers and stockists are reminded that under EC Health, Safety and Environment Law, when returning products to Spirax Sarco they must provide information on any hazards and the precautions to be taken due to contamination residues or mechanical damage which may present a health, safety or environmental risk. This information must be provided in writing including Health and Safety data sheets relating to any substances identified as hazardous or potentially hazardous.

— 2. General product information —

2.1 General description

The products detailed below are all strainers with flanged connections. They are used to protect other pipeline items from damage due to debris and dirt in the system. The Fig 7 strainer is a pot type design - all the others are Y-type designs. As standard, most Y-type strainers are fitted with stainless steel screens with 0.8 mm perforations. The Fig 7 is fitted with 3.2 mm perforations only (no optional extras are available for the Fig 7). Optional screens are available for the Y-type strainers only, see Section 2.2.

Note: For additional information see the following Technical Information Sheets:

Strainer	Body material	Body rating	Size	TI reference
Fig 3	Bronze body	PN25	DN15 - DN100	TI-P021-01
Fig 7	Carbon steel body	PN16	DN200 - DN250 only	TI-P063-03
Fig 33	Cast iron	PN16	DN15 - DN200	TI-S60-03
Fig 34 (DIN)	Carbon steel	PN40	DN15 - DN200	TI-P064-01
Fig 34 (ASTM)	Carbon steel	PN50 (ASME/ANSI 300)	DN15 - DN200	TI-P064-02
Fig 34HP	Carbon steel	PN100 (ASME/ANSI 600)	DN15 - DN200	TI-P168-01
Fig 36	Austenitic stainless steel	(ASME/ANSI 300)	DN15 - DN200	TI-P160-02
Fig 3616 (ASTM)	Austenitic stainless steel	(ASME/ANSI 150)	DN15 - DN200	TI-P160-04
Fig 3616 (DIN)	Austenitic stainless steel	PN16	DN15 - DN200	TI-P160-05
Fig 37	SG iron	PN40	DN15 - DN150	TI-P081-01
		PN25	DN200	TI-P081-01
Fig 3716	SG iron	PN16	DN15 - DN200	TI-P081-03

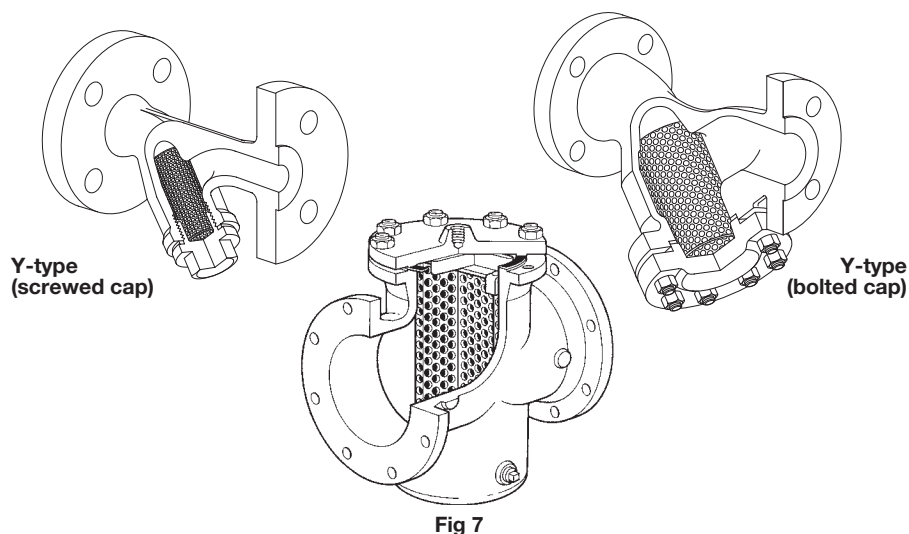

2.2 Optional extras

Strainer screens	Stainless steel screen	Perforations	1.6, 3 mm
		Mesh	40, 100, 200
	Monel screen (Not available for the Fig 3716)	Perforations	0.8, 3 mm
		Mesh	100

Blowdown or drain valve connections

The cap can be drilled and tapped to the following sizes to enable a blowdown or drain valve to be fitted.

Strainer	Size	Blowdown valve	Drain valve
Fig 3	DN15 to DN20	1/2"	1/2"
	DN25	3/4"	3/4"
	DN32 to DN40	1"	3/4"
	DN50	1 1/4"	3/4"
	DN65 to DN80	1 1/2"	3/4"
	DN100	2"	3/4"
Fig 33	DN15	1/4"	1/4"
	DN20 to DN25	1/2"	1/2"
Fig 34	DN32 to DN40	1"	3/4"
	DN50 to DN125	1 1/4"	3/4"
	DN150 to DN200	2"	3/4"
Fig 34HP	DN15	3/8"	3/8"
	DN20	1/2"	3/8"
	DN25	3/4"	1/2"
	DN40	1"	1/2"
	DN50	1"	3/4"
	DN65	1 1/4"	3/4"
	DN80	1 1/2"	3/4"
	DN100	1 1/2"	1"
	DN150	2"	1"
	DN200	2"	1 1/2"
Fig 36	DN15	1/4"	1/4"
	DN20 to DN25	1/2"	1/2"
Fig 37	DN32 to DN40	1"	3/4"
	DN50 to DN125	1 1/4"	3/4"
	DN150 to DN200	2"	3/4"
* Fig 3616	DN15 to DN20	3/8"	3/8"
* Fig 3716	DN25 to DN32	1/2"	1/2"
	DN40 to DN80	3/4"	3/4"
	DN100 to DN200	1"	3/4"

* **Note:** The Fig 3616 and Fig 3716 can be supplied with 1/4" tappings for pressure monitoring (upstream and downstream) of the strainer screen.

2.3 Pressure / temperature limits (ISO 6552)

Note: Values for PMA and TMA are not concurrent for exact operating limits.

Fig 3

Body design conditions	PN25	
PMA - Maximum allowable pressure	25 bar g	(363 psi g)
TMA - Maximum allowable temperature	250°C	(482°F)
Minimum operating temperature	0°C	(32°F)
Designed for a maximum cold hydraulic test pressure of:	38 bar g	(551 psi g)

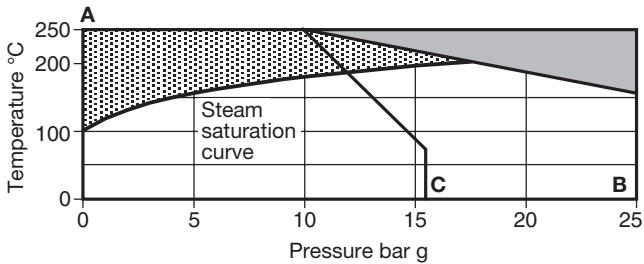

- The product **must not** be used in this region.
- For use in this region the castings may be resin impregnated to MIL/276 and DEF 03 - 1/2 standards.
- A - B** Flanged EN 1092 PN25
- A - C** Flanged ASME/ANSI 150

Fig 7

Body design conditions	PN16	
PMA - Maximum allowable pressure	16 bar g	(232 psi g)
TMA - Maximum allowable temperature	300°C	(572°F)
Minimum operating temperature	0°C	(32°F)
Designed for a maximum cold hydraulic test pressure of:	28 bar g	(406 psi g)

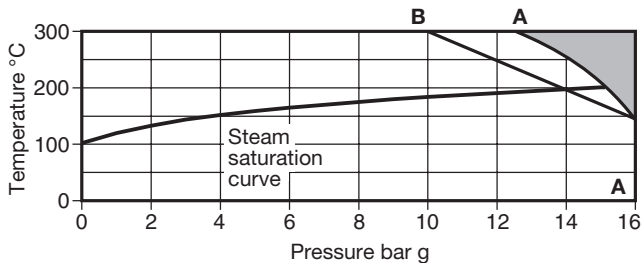

- The product **must not** be used in this region.
- A - A** Flanged EN 1092 PN16
- B - A** Flanged ASME/ANSI 150

Fig 33

Body design conditions	PN16	
PMA - Maximum allowable pressure	16 bar g	(232 psi g)
TMA - Maximum allowable temperature	300°C	(572°F)
Minimum operating temperature	0°C	(32°F)
Designed for a maximum cold hydraulic test pressure of:	24 bar g	(348 psi g)

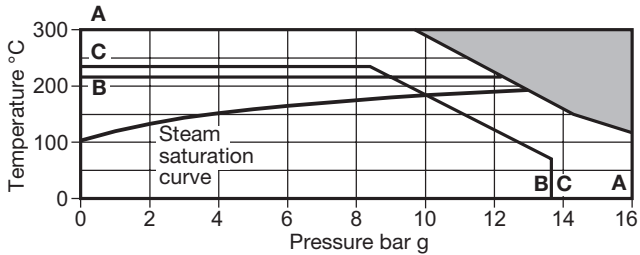

The product **must not** be used in this region.

- A - A** Flanged EN 1092 PN16
- B - B** Flanged AS 2129 Table F
- C - C** Flanged ASME/ANSI 125
(including DN15, DN20 flanged ASME/ANSI 150)

Fig 36

Body design conditions	ASME/ANSI 300 or PN50	
PMA - Maximum allowable pressure	41 bar g	(595 psi g)
TMA - Maximum allowable temperature	450°C	(842°F)
Minimum operating temperature	-29°C	(-20°F)
Designed for a maximum cold hydraulic test pressure of:	76 bar g	(1 102 psi g)

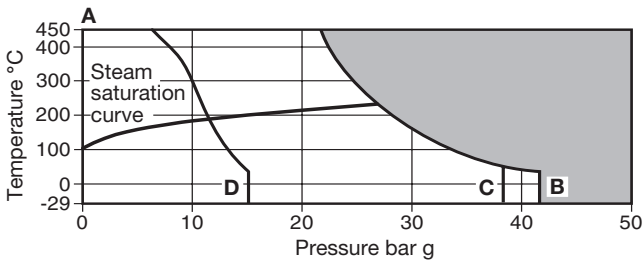

The product **must not** be used in this region.

- A - B** Flanged ASME/ANSI 300
- A - C** Flanged EN 1092 PN40
- C - D** Flanged ASME/ANSI 150

Fig 34 (DIN)

Body design conditions	PN40	
PMA - Maximum allowable pressure	40 bar g	(580 psi g)
TMA - Maximum allowable temperature	400°C	(752°F)
Minimum operating temperature	0°C	(32°F)
Designed for a maximum cold hydraulic test pressure of:	69 bar g	(1 000 psi g)

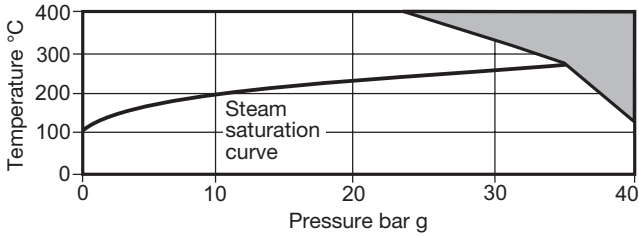



 The product **must not** be used in this region.

Fig 34 (ASTM)

Body design conditions	ASME/ANSI 300 or PN50	
PMA - Maximum allowable pressure	50 bar g	(725 psi g)
TMA - Maximum allowable temperature	400°C	(752°F)
Minimum operating temperature	0°C	(32°F)
Designed for a maximum cold hydraulic test pressure of:	78 bar g	(1 131 psi g)



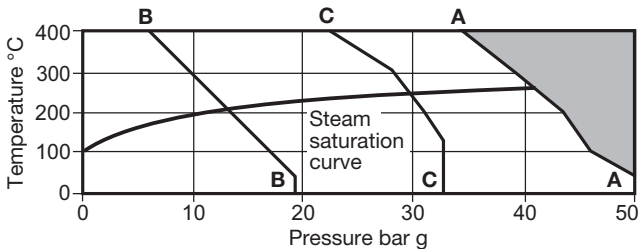

 The product **must not** be used in this region.

- A - A** Flanged ASME/ANSI 300
- B - B** Flanged ASME/ANSI 150
- C - C** Flanged JIS/KS 20

Fig 34HP (DIN)

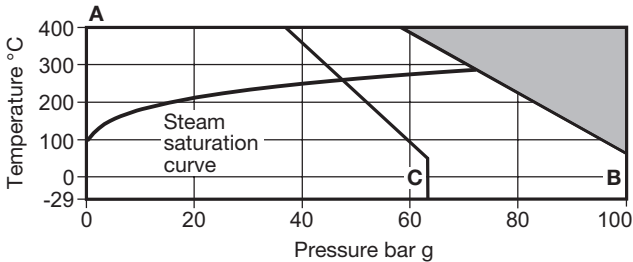
Body design conditions	PN63 and PN100		
PMA - Maximum allowable pressure	PN63	63 bar g @ 50°C	(914 psi g @ 122°F)
	PN100	100 bar g @ 50°C	(1 450 psi g @ 122°F)
TMA - Maximum allowable temperature	PN63	400°C @ 37.5 bar g	(752°F @ 544 psi g)
	PN100	400°C @ 59.5 bar g	(752°F @ 863 psi g)
Minimum operating temperature			-29°C (-20°F)
Designed for a maximum cold hydraulic test pressure of:	PN63	95 bar g	(1 378 psi g)
	PN100	150 bar g	(2 176 psi g)



 The product **must not** be used in this region.

A - B Flanged PN100
A - C Flanged PN63

Fig 34HP (ASTM)

Body design conditions	ASME (ANSI) 600	
PMA - Maximum allowable pressure	102 bar g @ 38°C	(1480 psi g @ 100°F)
TMA - Maximum allowable temperature	425°C @ 57.5 bar g	(797°F @ 833 psi g)
Minimum operating temperature	-29°C (-20°F)	
Designed for a maximum cold hydraulic test pressure of:	152 bar g	(2 204 psi g)

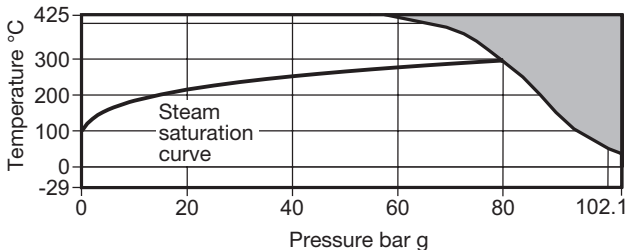

 The product **must not** be used in this region.

Fig 3616 (DIN)

Body design conditions	PN16	
PMA - Maximum allowable pressure	15 bar g	(217.5 psi g)
TMA - Maximum allowable temperature	300°C	(572°F)
Minimum operating temperature	-10°C	(14°F)
Designed for a maximum cold hydraulic test pressure of:	24 bar g	(348 psi g)

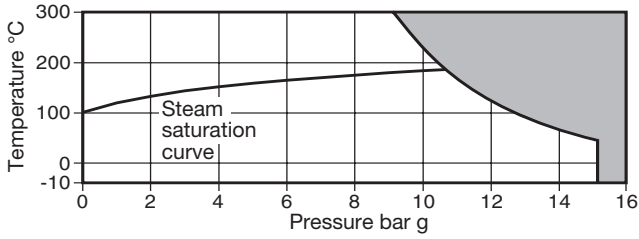

 The product **must not** be used in this region.

Fig 3616 (ASTM)

Body design conditions	ASME/ANSI 150	
PMA - Maximum allowable pressure	19 bar g	(275.5 psi g)
TMA - Maximum allowable temperature	400°C	(752°F)
Minimum operating temperature	-29°C	(-20°F)
Designed for a maximum cold hydraulic test pressure of:	30 bar g	(435 psi g)

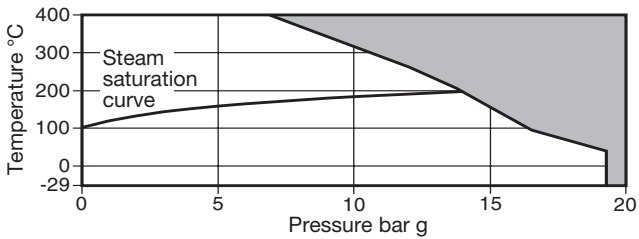

 The product **must not** be used in this region.

Fig 37

Body design conditions	PN40	
	DN200 only	PN25
PMA - Maximum allowable pressure		40 bar g (580 psi g)
	DN200 only	25 bar g (363 psi g)
TMA - Maximum allowable temperature		350°C (662°F)
		-10°C (14°F)
Minimum operating temperature	DN65 and above	0°C (32°F)
Designed for a maximum	PN40	60 bar g (870 psi g)
cold hydraulic test pressure of:	PN25 DN200 only	38 bar g (551 psi g)

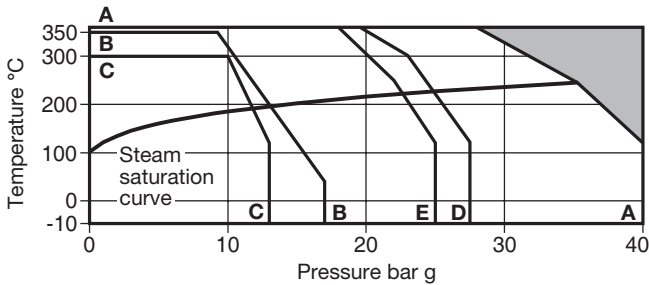

This product **must not** be used in this region.

- A - A** Flanged EN 1092 PN40
- B - B** Flanged ASME/ANSI 150
- C - C** Flanged JIS/KS 10K
- A - D** Flanged JIS/KS 20K
- A - E** Flanged EN 1092 PN25

Fig 3716 (DIN)

Body design conditions	PN16	
PMA - Maximum allowable pressure		16 bar g (232 psi g)
TMA - Maximum allowable temperature		300°C (662°F)
Minimum operating temperature		-10°C (14°F)
Designed for a maximum cold hydraulic test pressure of:		24 bar g (348 psi g)

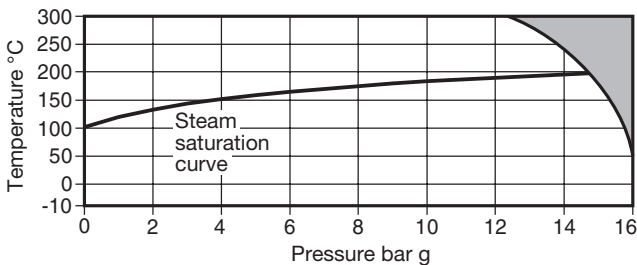

The product **must not** be used in this region.

3. Installation

Note: Before actioning any installation observe the 'Safety information' in Section 1.

Referring to the installation and Maintenance Instructions, name-plate and Technical Information Sheet, check that the product is suitable for the intended installation:

- 3.1** Check materials, pressure and temperature and their maximum values. If the maximum operating limit of the product is lower than that of the system in which it is being fitted, ensure that a safety device is included in the system to prevent overpressurisation.
- 3.2** Determine the correct installation situation and the direction of fluid flow.
- 3.3** Remove protection covers from all connections and protective film from all name-plates, where appropriate, before installation on steam or other high temperature applications.
- 3.4** Strainers can be fitted on liquid or steam/gas systems in either horizontal pipework or vertical pipework where the flow is downward. In a horizontal line on steam/gases the strainer pocket should be in the horizontal plane as this reduces the possibility of waterhammer. On liquid systems the strainer pocket should point downwards.
- 3.5** The strainers may be lagged if required.

4. Commissioning

After installation or maintenance ensure that the system is fully functional. Carry out tests on any alarms or protective devices.

5. Operation

Strainers are passive items and will prevent the onward movement of dirt and debris, which is larger than the holes in the screen. The pressure drop across the strainer will increase as the screen becomes blocked. Regular cleaning / blowdown is recommended to keep the screen clean.

6. Fault finding

Symptom	Possible cause	Remedy
No flow through strainer	Blocked screen	Clean or replace screen See Section 7.2
	System is isolated	Check isolation valves
Increased pressure drop across strainer	Screen is blocked up	Clean or replace screen See Section 7.2

Strainer installed on steam or gas

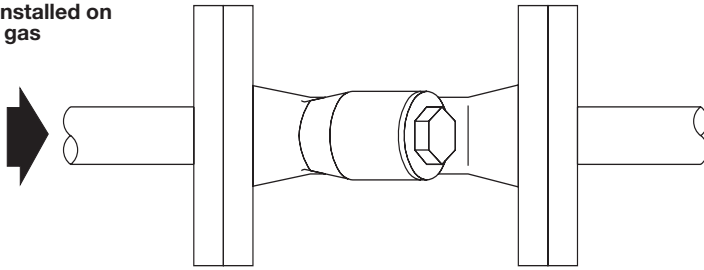

Strainer installed on liquid

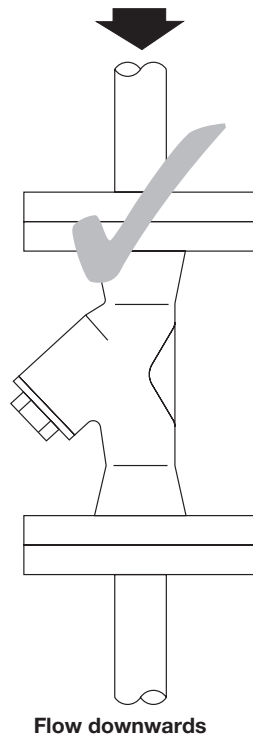
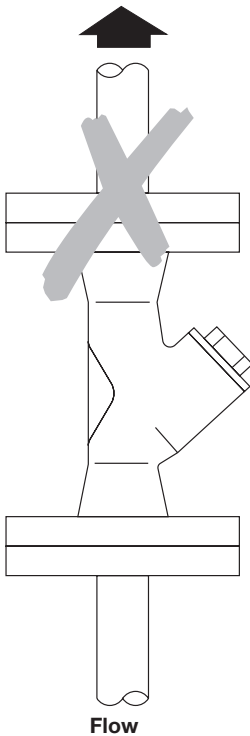
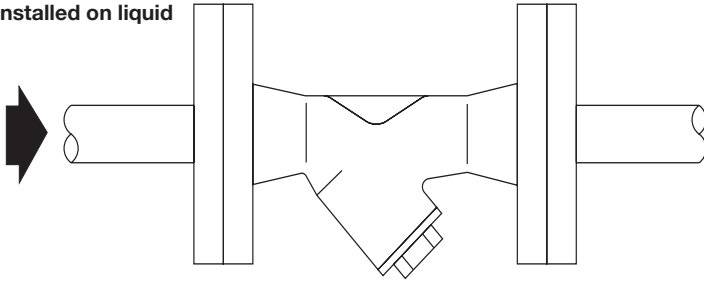

7. Maintenance

Note: Before actioning any maintenance programme observe the 'Safety information' in Section 1.

Warning

The cover gasket contains a thin stainless steel support ring which may cause physical injury if not handled and disposed of carefully.

7.1 General information

Before undertaking any maintenance on the strainer, it must be isolated from both the supply line and return line and any pressure allowed to safely normalise to atmosphere. The trap should then be allowed to cool. When reassembling, ensure that all joint faces are clean.

7.2 How to clean or replace the strainer screen:

For identification of parts refer to Section 8 'Spare parts'

- Remove the strainer cap.
- On most sizes up to DN25 the cap is simply unscrewed.
- On all other sizes the cap is retained by bolts/nuts. The number of bolts/nuts used will depend on the strainer size, material of construction and design rating.
- Once the cap is removed the strainer screen can be taken out.
- Clean the screen or replace with a new one.
- Reassemble the screen into the cap by pushing the end into the recess.
- Always fit a new strainer cap gasket ensuring the jointing faces are clean.
- Refit the strainer cap or bolts/nuts using 'Neverseize' compound and tighten to the recommended torque (refer to the relevant Table, pages 17 to 19).
- Ensure that the nuts are tightened equally before final torque is applied.
- Check for leaks.

Fig 3 strainer - Recommended tightening torques







Item	Qty	Size	 or 	mm	N m	(lbf ft)
2	1	DN15	 or 	26 A/F	1" BSP x ²⁹ / ₆₄ "	42 - 48 (31 - 35)
	1	DN20			1 1/4" BSP x ³⁷ / ₆₄ "	70 - 80 (51 - 59)
	1	DN25			1 3/4" BSP x ⁴¹ / ₆₄ "	124 - 144 (91 - 106)
5, 6	4	DN32 and DN40	 or 	3/8" UNF x 3/4"	20 - 24 (15 - 18)	
	4	DN50 and DN65			3/8" UNF x 1 1/4"	20 - 24 (15 - 18)
	6	DN80			7/16" UNF x 1 1/2"	50 - 55 (37 - 40)
	12	DN100			1/2" UNF x 2"	50 - 55 (37 - 40)

Fig 7 strainer - Recommended tightening torques







Item	Qty	Size	 or 	mm	N m	(lbf ft)
6	8	DN200	 or 	(3/4 UNC) to BS 1769	80 - 90 (59 - 66)	
	10	DN250			110 - 120 (81 - 88)	
7	1	DN200	 or 	3/4" BSP	50 - 55 (37 - 40)	
	1	DN250			1" BSP	50 - 55 (37 - 40)

Fig 33 strainer - Recommended tightening torques







Item	Qty	Size	 or 	mm	N m	(lbf ft)
2	1	DN15	 or 	22 A/F	M28	50 - 55 (37 - 40)
	1	DN20			M32	60 - 66 (44 - 49)
	1	DN25			M42	100 - 110 (74 - 81)
	1	DN32			M56	150 - 165 (110 - 121)
	1	DN40			M60	170 - 185 (125 - 136)
	1	DN50			M72	190 - 210 (140 - 154)
5	8	DN65	 or 	19 A/F	M12 x 40	20 - 24 (15 - 18)
	8	DN80			M12 x 40	30 - 35 (22 - 26)
	8	DN100			M16 x 50	70 - 77 (51 - 57)
	8	DN125			M16 x 50	80 - 88 (59 - 65)
	8	DN150			M20 x 60	100 - 110 (74 - 81)
	12	DN200			M20 x 70	90 - 100 (66 - 74)

Fig 34 strainer - Recommended tightening torques







Item	Qty	Size	 or 	mm	N m	(lbf ft)
2	1	DN15	 or 	22 A/F	M28	50 - 55 (37 - 40)
	1	DN20			M32	60 - 66 (44 - 49)
	1	DN25			M42	100 - 110 (74 - 87)
5	4	DN32	 or 	19 A/F	M12 x 30	20 - 24 (15 - 18)
	4	DN40			M12 x 30	20 - 24 (15 - 18)
	6	DN50			M12 x 35	20 - 24 (15 - 18)
	8	DN65			M12 x 35	20 - 24 (15 - 18)
	8	DN80			M12 x 35	30 - 35 (22 - 26)
	8	DN100			M16 x 45	50 - 55 (37 - 40)
	8	DN125			M20 x 50	70 - 77 (51 - 57)
	8	DN150			M20 x 55	80 - 88 (59 - 65)
	12	DN200			M24 x 65	120 - 130 (88 - 96)

Fig 34HP strainer - Recommended tightening torques



Item	Qty	Size	 or mm		N m	(lbf ft)
5	4	DN15	3/4" A/F	1/2" - 13 UNC	20 - 30	
	4	DN20	3/4" A/F	1/2" - 13 UNC	20 - 30	
	4	DN25	3/4" A/F	1/2" - 13 UNC	20 - 30	
	8	DN40	3/4" A/F	1/2" - 13 UNC	30 - 40	
	8	DN50	3/4" A/F	1/2" - 13 UNC	30 - 40	
	8	DN65	1 1/16" A/F	5/8" - 11 UNC	50 - 60	
	8	DN80	1 1/16" A/F	5/8" - 11 UNC	50 - 60	
	8	DN100	1 1/4" A/F	3/4" - 10 UNC	80 - 90	
	8	DN150	1 7/16" A/F	7/8" - 9 UNC	100 - 110	
	12	DN200	1 13/16" A/F	1 1/4" - 7 UNC	180 - 190	

Fig 36 strainer - Recommended tightening torques



Item	Qty	Size	 or mm		N m	(lbf ft)
5	4	DN15 and DN20	17 A/F	M10 x 25	22 - 25	(16 - 18)
	4	DN25	17 A/F	M10 x 25	22 - 25	(16 - 18)
	4	DN32 and DN40	19 A/F	M12 x 35	40 - 45	(29 - 33)
	8	DN50	19 A/F	M12 x 35	40 - 45	(29 - 33)
	8	DN65	19 A/F	M12 x 45	40 - 45	(29 - 33)
	8	DN80	19 A/F	M12 x 50	40 - 45	(29 - 33)
	8	DN100	24 A/F	M16 x 50	100 - 110	(73 - 80)
	8	DN125	30 A/F	M20 x 60	160 - 170	(117 - 125)
	8	DN150	30 A/F	M20 x 65	210 - 230	(154 - 169)
	8	DN200	36 A/F	M20 x 75	210 - 230	(154 - 169)

Fig 3616 strainer - Recommended tightening torques



Item	Qty	Size	 or mm		N m	(lbf ft)
5	4	DN15 and DN20	13 A/F	M8 x 20	15 - 20	(11 - 15)
	4	DN25	13 A/F	M8 x 20	15 - 20	(11 - 15)
	4	DN32 and DN40	13 A/F	M8 x 20	15 - 20	(11 - 15)
	4	DN50	17 A/F	M10 x 25	22 - 25	(16 - 18)
	4	DN65	17 A/F	M10 x 30	22 - 25	(16 - 18)
	6	DN80	17 A/F	M10 x 30	22 - 25	(16 - 18)
	6	DN100	19 A/F	M12 x 35	50 - 60	(37 - 44)
	8	DN125	19 A/F	M12 x 40	50 - 60	(37 - 44)
	8	DN150	19 A/F	M12 x 40	50 - 60	(37 - 44)
	8	DN200	24 A/F	M16 x 50	100 - 110	(74 - 81)

Fig 37 strainer - Recommended tightening torques





Item	Qty	Size	or		N m	(lbf ft)
				mm 		
2	1	DN15	22 A/F	M28	50 - 55	(37 - 40)
	1	DN20	27 A/F	M32	60 - 66	(44 - 49)
	1	DN25	27 A/F	M42	100 - 110	(74 - 81)
	1	DN32	46 A/F	M56	250 - 275	(184 - 202)
	1	DN40	50 A/F	M60	250 - 275	(184 - 202)
	1	DN50	60 A/F	M72	310 - 340	(228 - 250)
5	8	DN65	19 A/F	M12 x 35	20 - 24	(15 - 18)
	8	DN80	19 A/F	M12 x 35	30 - 35	(19 - 26)
	8	DN100	24 A/F	M16 x 45	50 - 55	(37 - 40)
	8	DN125	30 A/F	M20 x 50	80 - 88	(59 - 65)
	8	DN150	30 A/F	M20 x 55	100 - 110	(74 - 81)
	12	DN200	36 A/F	M24 x 65	90 - 100	(66 - 74)

Fig 3716 strainer - Recommended tightening torques

Item	Qty	Size	or		N m	(lbf ft)
				mm 		
5	4	DN15 and DN20	13 A/F	M8 x 20	15 - 20	(11 - 15)
	4	DN25	13 A/F	M8 x 20	15 - 20	(11 - 15)
	4	DN32 and DN40	13 A/F	M8 x 20	15 - 20	(11 - 15)
	4	DN50	17 A/F	M10 x 25	22 - 25	(16 - 18)
	4	DN65	17 A/F	M10 x 30	22 - 25	(16 - 18)
	6	DN80	17 A/F	M10 x 30	22 - 25	(16 - 18)
	6	DN100	19 A/F	M12 x 35	50 - 60	(37 - 44)
	8	DN125	19 A/F	M12 x 40	50 - 60	(37 - 44)
	8	DN150	19 A/F	M12 x 40	50 - 60	(37 - 44)
	8	DN200	24 A/F	M16 x 50	100 - 110	(74 - 81)

8. Spare parts

The only parts that are available as spares are detailed in the table below.

Available spares

Strainer screen (state material, mesh, perforation and size of strainer)

4

Note: The Fig 7 pot type is only available with 3.2 mm perforated stainless steel

Cap gasket (packet of three)

3

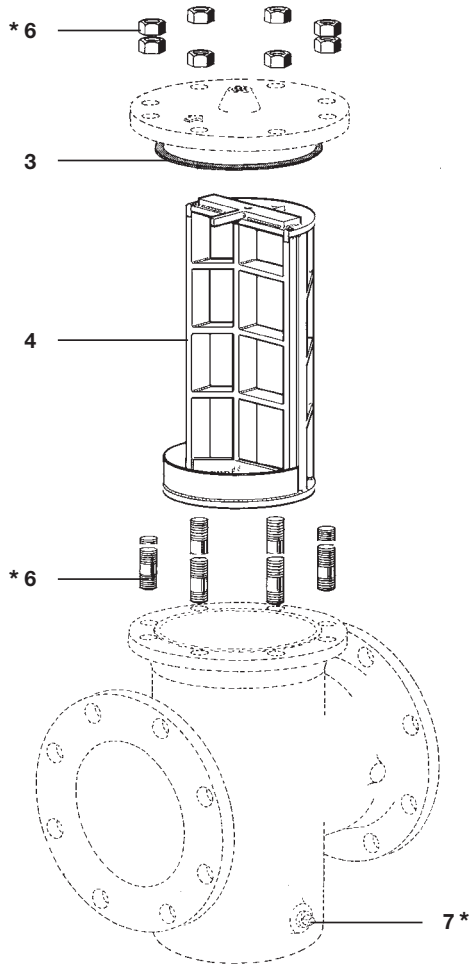
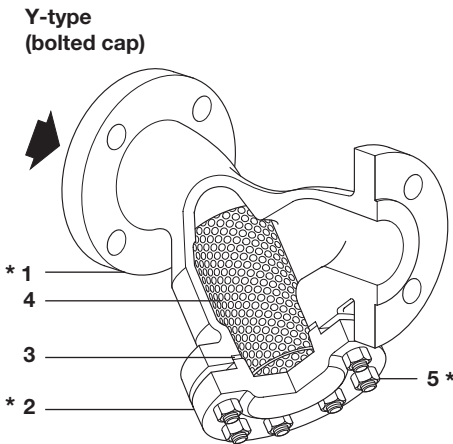
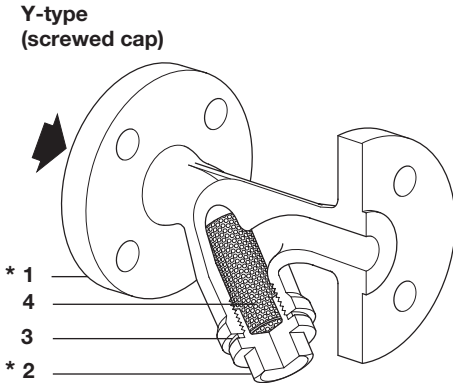

Fig 7

* **Note:** Items 1, 2, 5, 6 and 7 are annotated for identification of parts relating to the tightening torques on pages 17, 18 and 19.

How to order spares

Always order spares by using the description given in the column headed 'Available spares' and state the size, model no. and pressure rating of the trap.

Example: 1 off 100 mesh stainless steel screen for a DN100 Fig 34 steel strainer.