

**BC3200 and BC3210  
Blowdown Controllers  
Installation and Maintenance Instructions**

---

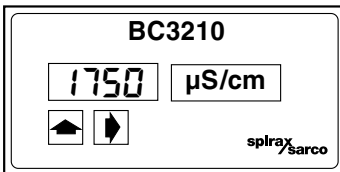

1. *General safety information*
2. *General product information*
3. *Operation*
4. *Installation*
5. *Setting up the controller*
6. *Wiring diagram*
7. *Commissioning*
8. *Maintenance*
9. *Fault finding*
10. *Appendix - CCD applications*

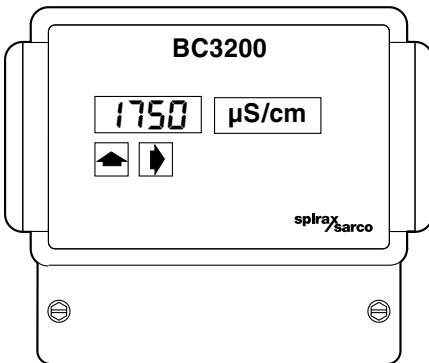

# 1. General safety information

Your attention is drawn to Safety Information Sheet IM-GCM-10, as well as to any National or Local regulations concerning boiler blowdown. In the UK, guidance is given in HSE Guidance Note PM60.

Safe operation of the product depends on it being properly installed, commissioned and maintained by a qualified person in compliance with the operating instructions.

It is essential to comply with general installation and safety instructions for pipeline and plant construction, as well as to make proper use of tools and safety equipment.

The product is designed and constructed to withstand the forces encountered during normal use. Use of the product for any other purpose, or failure to install the product in accordance with these Installation and Maintenance Instructions, could cause damage to the product, will invalidate the **CE** marking and may cause injury or fatality to personnel.

## Warning

Two connector plugs and sockets are provided on each controller, with input and output connections clearly indicated on the printed circuit board.

The connector socket carrying the mains input is numbered 11 - 20 and must never be connected to the printed circuit board plug labelled 1 - 10, as this would destroy the equipment and cause a risk of fatal electric shock to personnel.

Isolate the mains supply before unplugging the controller since hazardous voltages will be exposed on the controller base. This product complies with the requirements of Electromagnetic Compatibility Directive 89/336/EEC by meeting the standards of:

- BS EN 50081-1 (Emissions) and
- BS EN 50082-1 (Immunity).

The following conditions should be avoided as they may create interference above the limits specified in BS EN 50082-1 if:

- The product or its wiring is located near a radio transmitter.
- Excessive electrical noise occurs on the mains supply. Power line protectors (ac) should be installed if mains supply noise is likely. Protectors can combine filtering, suppression, surge and spike arrestors.
- Cellular telephones and mobile radios may cause interference if used within approximately 1 metre (39") of the product or its wiring. The actual separation distance necessary will vary according to the surroundings of the installation and the power of the transmitter.

All wiring materials and methods shall comply with relevant EN and IEC standards where applicable.

If the product is not used in the manner specified in this IMI,  
then the protection provided may be impaired.

## — 2. General product information —

### 2.1 General description

The BC3200 and BC3210 are dual voltage controllers which monitor the conductivity of liquids, and are used with a boiler blowdown valve or condensate dump valve to monitor and control TDS levels.

The BC3200 is wall mounted, and the BC3210 panel mounted. As they are the same in nearly all other respects, the following information will, for clarity, refer to the BC3200.

The front panel has a four digit LED display and two push buttons to select, view, and change parameters or settings. An optional lockable cover assembly is available for the BC3210. An optional lock is available for the BC3200.

In normal operation the display shows the actual Total Dissolved Solids (TDS) value.

**Note: TDS is expressed in parts per million (ppm). The use of  $\mu\text{S}/\text{cm}$  (micro Siemens per centimetre) is becoming more common as a measure of conductivity.**

Voltage, ranges, and other operating parameters are set on installation using internal switches. When used with the CP32 twin tip conductivity probe, the controller is able to detect scaling (UK Patent No. 2297843). It can also automatically initiate a probe cleaning (conditioning) cycle (UK Patent No. 2276943). This causes any scale on the probe to become porous or fall off, allowing the probe to continue to sense at its original calibration level. It should not, however, be regarded as a substitute for adequate water treatment. The cleaning time can be adjusted.

**Note: The controller does not monitor conductivity or release the control or alarm relay during the probe cleaning cycle.**

If a two-tip probe is fitted the controller can be set to display a fault code, release an alarm relay, and/or carry out a probe cleaning cycle if the probe becomes scaled.

The controller has adjustable set point, alarm, and calibration. The set point hysteresis is adjustable, to provide a damping effect where changes in water movement at the probe may otherwise cause over-frequent switching of the blowdown or dump valve.

Changes in circulation could be caused, for example, by boiler firing rate variations, by the feedpump operating, or by sudden changes in boiler load.

A Pt100 temperature sensor may be connected to the controller to provide temperature compensation ( $2\%/^{\circ}\text{C}$ ). This is recommended if the boiler is working at varying pressures, or for other applications such as condensate monitoring or coil boilers, where the temperature may vary. The Spirax Sarco CP32 probe has an integral temperature sensor.

For smaller boilers where the capacity of the blowdown valve is relatively high compared to the boiler size, the blowdown may be set to pulsed, rather than continuous output, opening for 10 seconds, and closing for 20 seconds. This slows the rate at which the boiler water is removed so that the level is not unduly affected, avoiding the risk of triggering a low water alarm.

A 0 - 20 or 4 - 20 mA output is provided as standard, and may be used for remote display of TDS level or as an output to a computerised management system.

A security feature can be selected which allows settings to be viewed but not adjusted, preventing unwanted or inadvertent changes being made.

The BC3200 can be used for installations with continuous or intermittent flow past the TDS sensor. Continuous flow is chosen where the probe is mounted directly in the boiler shell, for coil boilers, or for condensate contamination detection.

Intermittent flow is used where the probe is mounted in the blowdown line.

An additional filter can be selected to increase the damping effect where the probe is fitted directly in the boiler.

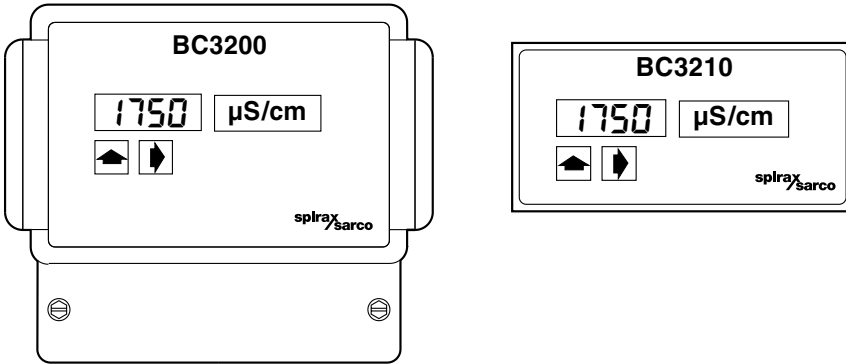

Fig. 1 BC3200 wall mounted and BC3210 panel mounted controllers

## 2.2 Technical data

|   |  |
|---|--|
| <b>Maximum ambient temperature</b>                | 55°C (131°F)   |
| <b>Minimum ambient temperature</b>                | 0°C (32°F)   |
| <b>Minimum conductivity</b>                       | 10 µS/cm or 10 ppm   |
| <b>Pollution degree</b>                           | 2  |
| <b>Overvoltage category</b>                       | II   |
| <b>Indoor use only</b>                            |  |
| <b>Altitude up to</b>                             | 2 000 m (6 561.5 ft)   |
| <b>Humidity</b>                                   | Maximum relative humidity 80% for temperatures up to 31°C (87.8°F) decreasing linearly to 50% relative humidity at 40°C (104°F).               |
| <b>Protection rating</b>                          | IP65 (front panel only on BC3210)  |
| <b>Mains supply voltage</b>                       | <b>230 V setting</b> 198 V - 264 V   |
|   | <b>115 V setting</b> 99 V - 132 V  |
| <b>Frequency</b>                                  | 50 - 60 Hz   |
| <b>Fuse type</b>                                  | 20 mm cartridge, 100 mA anti-surge (T). For the UL version, replacement fuses must be UL recognised to maintain the integrity of the approval. |
| <b>Maximum power consumption</b>                  | 6 VA   |
| <b>Maximum cable length (controller to probe)</b> | 100 m (328 ft)*  |
| <b>Terminal torque rating</b>                     | 1 N m (9 lbf in)   |

\* For the CP10, see Section 6.4.3.

# 3. Operation

## 3.1 Continuous flow (probe in boiler)

The BC3200 can be set to operate with a Spirax Sarco single or two-tip TDS probe. For systems where the probe is in a continuous flow, the BC3200 will open the blowdown or dump valve if the conductivity of the water exceeds a certain level (set point). When the TDS falls to the set point (less the hysteresis value), the controller will close the valve.

## 3.2 Intermittent flow (probe in blowdown line)

For systems where the sensor is mounted in the blowdown line, the controller periodically opens the blowdown valve to allow a sample of water from the boiler to pass the sensor (purge).

If the TDS is below the set point, the valve will close after the purge time has elapsed.

If the TDS level is above the set point, the blowdown valve will remain open to allow the high TDS water to be replaced by clean water from the feedtank.

The valve will close when the TDS level falls to the set point (less the hysteresis value). The controller will store the TDS level in memory so that the last true value is always shown on the display and is output as the mA signal.

The diagrams in Section 3.3 show the purge time, time between purges, and conductivity control for a typical system.

The purge time is adjustable for different blowdown installations, to ensure that all water from the previous sample has been removed from the system, and that the sample is at a similar temperature to the water in the boiler.

The BC3200 may be set to purge either half an hour from the last purge, or after every half hour of boiler firing, (useful for stand-by boilers). A 'manual' purge may be carried out whenever the TDS level is displayed by pressing the '➡' button.

## 3.3 Typical operation (intermittent flow)

**T1** - Purge time (PurG). Adjustable 0 - 99 seconds or 0 - 0.99 hour.

**T2** - Time between purges. Every half hour or every half hour of boiler firing, depending on how the controller is wired.

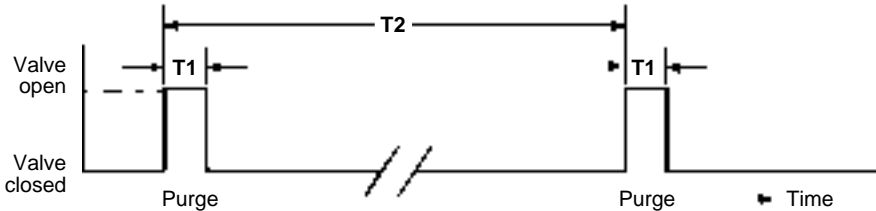

Fig. 2 Measured conductivity lower than the set point

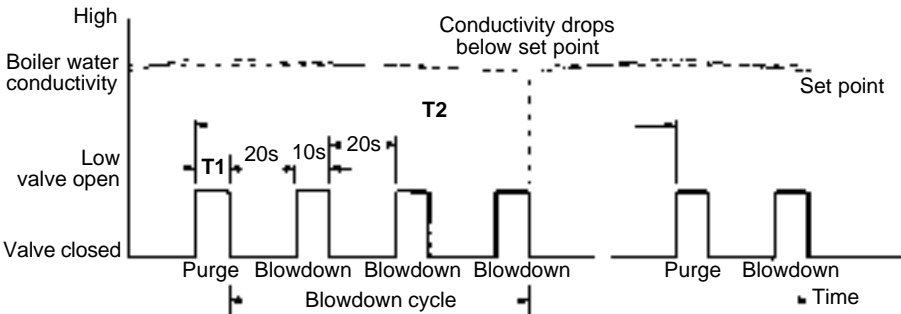

Fig. 3 Conductivity being controlled near to set point

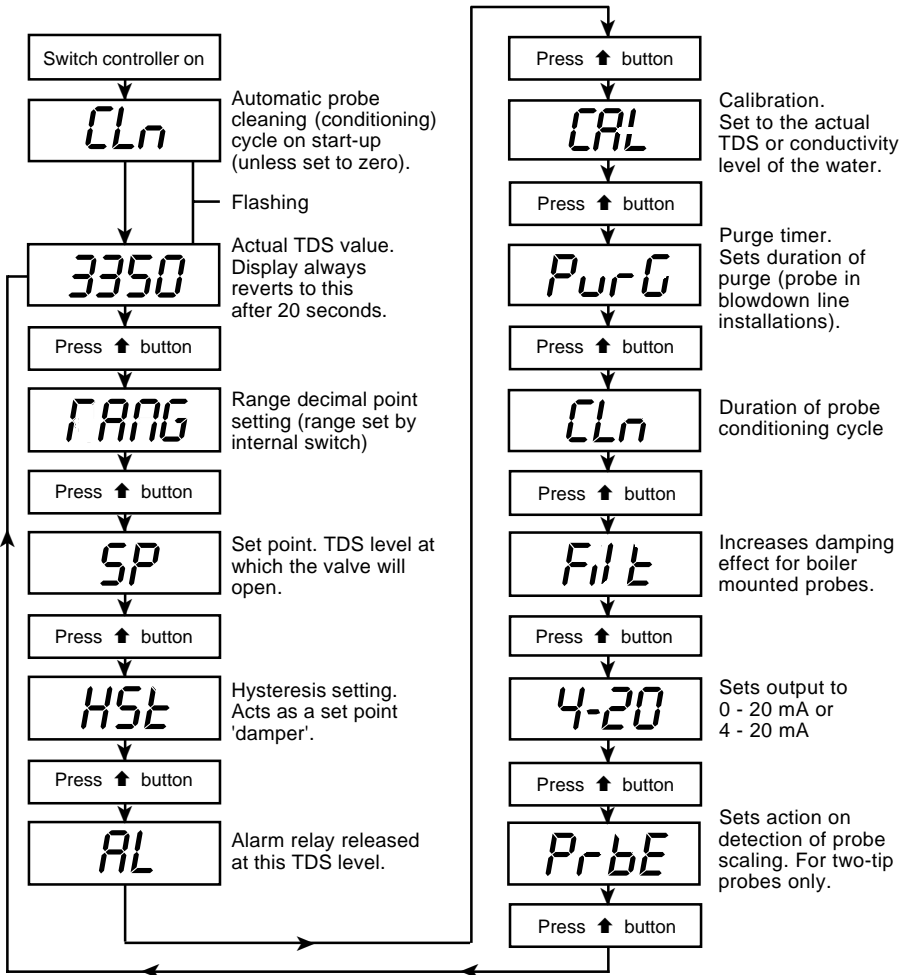

Fig. 4 Summary of display operation

See Section 7 'Commissioning' for full explanation of the functions, and to view / change settings.

---

## 4. Installation

---

### 4.1 BC3200

The BC3200 is designed for wall mounting using the three screw slots provided. Mounting dimensions are marked on the base of the enclosure.

### 4.2 BC3210

The BC3210 must be mounted in the panel of a suitable industrial control panel or fireproof enclosure to provide environmental protection (pollution degree 2). The dimensions of the cut-out are 137 mm x 67 mm (5.4" x 2.6"). Two retaining clips are slotted into the sides of the case and carry retaining screws which are tightened against the back of the boiler panel.

The controller is for installation category II (overvoltage category) and must be installed in accordance with IEC 60364 or equivalent. For US and Canadian markets the controller must be wired in accordance with the National and Local Electrical Code (NEC) or Canadian Electrical Code (CEC). The controller and all connected circuits must have a common isolation system which meets the relevant requirements of IEC 60947-1 and IEC 60947-3 or equivalent. This must be positioned close to the controller and clearly identified as the disconnect device. Quick blow external fuses must be fitted in all phases of the controller supply, burner input and relays. The relays are rated at 250 V and must be on the same phase as the controller supply. See notes on wiring diagram (Section 6.1, page 15) for fuse ratings.

Cabling should be installed in accordance with BS 6739 - Instrumentation in process control systems: Installation design and practice or local equivalent.

**Note:** The wiring diagrams (Section 6) show all relays in the power off position.

---

## 5. Setting up the controller

---

### 5.1 BC3200

- Ensure that the mains supply is not connected.
- Loosen the two bottom cover retaining screws, and remove the cover.

**Note:** A two-way mains switch and 8-way function switch on the printed circuit board (PCB) are fitted just behind the connector plugs.

- Set the switches to the positions shown in the diagrams (pages 10 to 13) for the chosen voltage and duties.
- Refit the bottom cover.

**Connectors must not be transposed; see Section 1 'General safety information'.**

**Fuse:** Follow the above procedure for access to the fuse, which is next to the mains switch, see Figure 5.

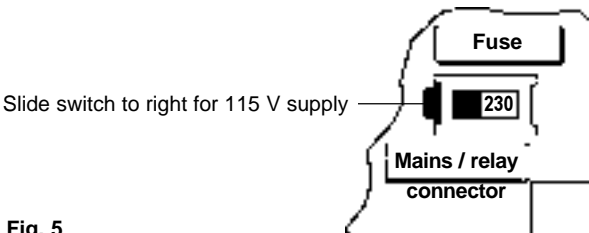

Fig. 5

## 5.2 BC3210

- **Ensure that the mains supply is not connected.**

- Unplug the two connector sockets from the back of the unit.
- Remove the four rear panel retaining screws.
- Carefully slide out the PCB. Damage to the internal cable and components can occur if the PCB is pulled out completely. If it is necessary to remove the PCB completely, carefully disconnect the cable on the main PCB. **Note:** the connector is polarised and therefore can only be reconnected in one orientation.

**Note:** A two-way mains switch and 8-way function switch on the PCB are fitted just behind the connector plugs.

- Set the switches to the positions shown on pages 10 to 13 for the chosen voltage and duties.
- Refit the PCB and rear cover.
- Refit the two connector sockets.

**Connectors must not be transposed; see Section 1 'General safety information'.**

**Fuse:** Follow the above procedure for access to the fuse, which is next to the mains switch, see Figure 5.

## 5.3 Controller - factory settings

The controller is supplied set as follows:

- 1000 - 9990 ppm.
- Single tip probe (CP10, CP30).
- No temperature sensor fitted.
- Continuous blowdown valve operation.
- Security OFF.

Fig. 6

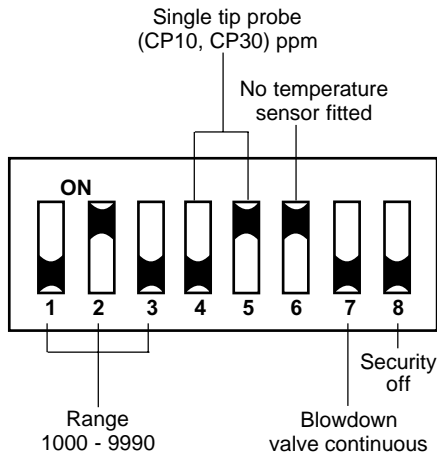

## 5.4 Range - switches 1, 2 and 3

The controller is supplied set to a range of 1000 - 9990, with switches 1 and 3 OFF, and switch 2 ON (Fig. 7), which is suitable for most boiler TDS control applications.

For condensate return monitoring duties, or boilers working at a low TDS, it may be desired to select a lower range for greater accuracy.

To select a range of 100 - 999.0, set switch 1 ON, and switches 2 and 3 OFF (Fig. 8).

To select a range of 10 - 99, set switches 1 and 2, OFF, and switch 3 ON (Fig. 9).

The minimum practical set point is 10  $\mu\text{S/cm}$  or 10 ppm.

**Fig. 7**  
Range 1000 - 9990  
( $\mu\text{S/cm}$  or ppm)

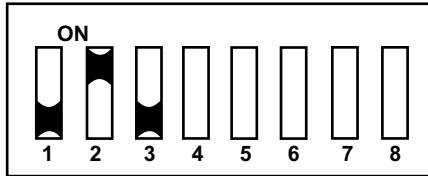

**Fig. 8**  
Range 100 - 999  
( $\mu\text{S/cm}$  or ppm)



**Fig. 9**  
Range 10 - 99  
( $\mu\text{S/cm}$  or ppm)

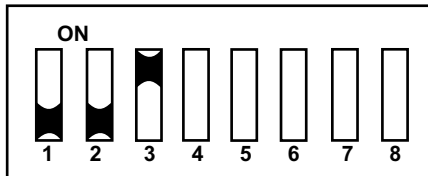

## 5.5 Probe type ppm or $\mu\text{S}/\text{cm}$ - switches 4, 5 and 6

Switches 4, 5 and 6 are set according to the type of probe used and the display units required. The controller is supplied set to indicate TDS in parts per million (ppm), with switch 4 OFF (Fig. 10). If a display in micro Siemens per centimetre ( $\mu\text{S}/\text{cm}$ ) is required, set switch 4 to ON (Fig. 11).

**Fig. 10**  
CP10 / CP30, ppm

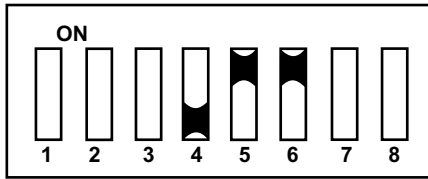
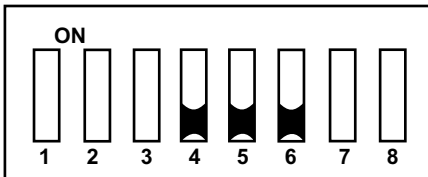

**Fig. 11**  
CP10 / CP30,  $\mu\text{S}/\text{cm}$



The controller is supplied set to work with a single tip probe (CP10, CP30). See Section 5.3, Fig. 6. If a two tip probe is used (CP32), set switch 5 and 6 to OFF.

**Fig. 12**  
CP32, ppm



**Fig. 13**  
CP32,  $\mu\text{S}/\text{cm}$

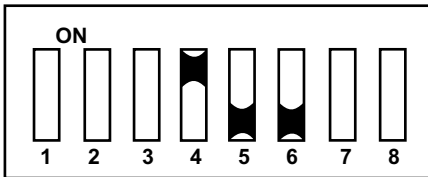

## 5.6 Temperature compensation - switch 6

The controller is supplied set for use without a temperature sensor (Fig. 14). For coil boilers, condensate monitoring, or situations where the boiler is likely to be working over widely varying pressures, a temperature sensor should be fitted. If this is the case, set switch 6 to the OFF position (Fig. 15). **Note:** that switch 6 is set to OFF if a CP32 probe is used, see Section 5.5.

**Fig. 14**  
Temperature sensor  
NOT fitted

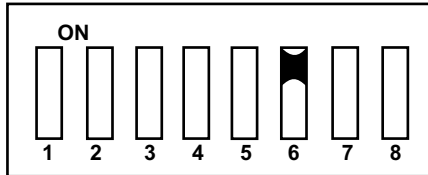

**Fig. 15**  
Temperature sensor  
fitted

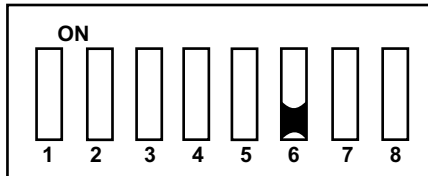

## 5.7 Blowdown valve operation - switch 7

This feature is suitable for use with solenoid or pneumatic valves only. It must not be used with motorised valves.

As supplied, (Fig. 16, switch 7 OFF), the boiler blowdown (or condensate dump) valve will remain open continuously while the TDS level is too high.

For smaller boilers where the capacity of the blowdown valve is relatively high compared to the boiler size, continuous valve operation may lower the boiler water level significantly, perhaps even enough to trigger an alarm.

If it is felt that this situation could occur, set switch 7 to ON (Fig. 17).

The valve will then open for 10 seconds, and close for 20 seconds, slowing the rate at which the boiler water is removed so that the level is not unduly affected.

**Fig. 16**  
Continuous valve  
operation

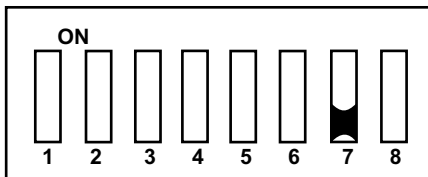

**Fig. 17**  
Pulsed valve  
operation

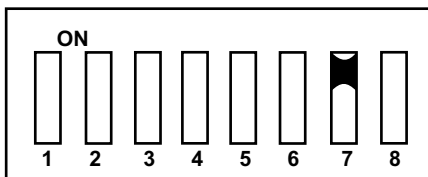

---

## 5.8 Security feature - switch 8

The controller is supplied with switch 8 OFF (Fig. 18), and will allow any of the parameters to be set or changed. To prevent unwanted or inadvertent changes being made to the settings, set switch 8 to ON (Fig. 19).

The controller will then only allow the calibration to be changed, though the other settings can still be viewed. A manual purge can be made (if the purge timer has been set).

**Fig. 18**  
Security off

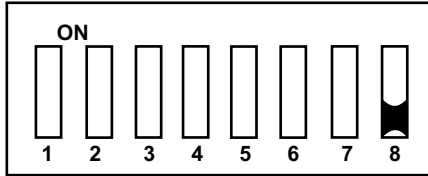

**Fig. 19**  
Security on

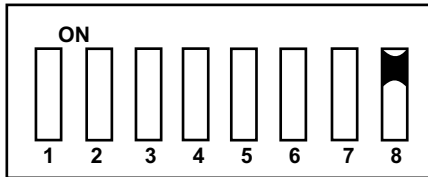

# 6. Wiring diagram

BC3200 / BC3210 230 V / 115 V

Ensure resistance from probe body to pipework/boiler shell is less than 1 Ω.

Do not connect terminals 4, 6, and 7 directly to earth.  
They must only be earthed via the probe wiring.

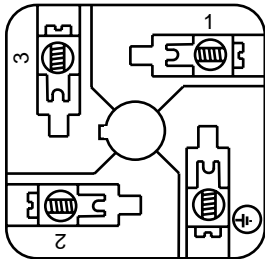
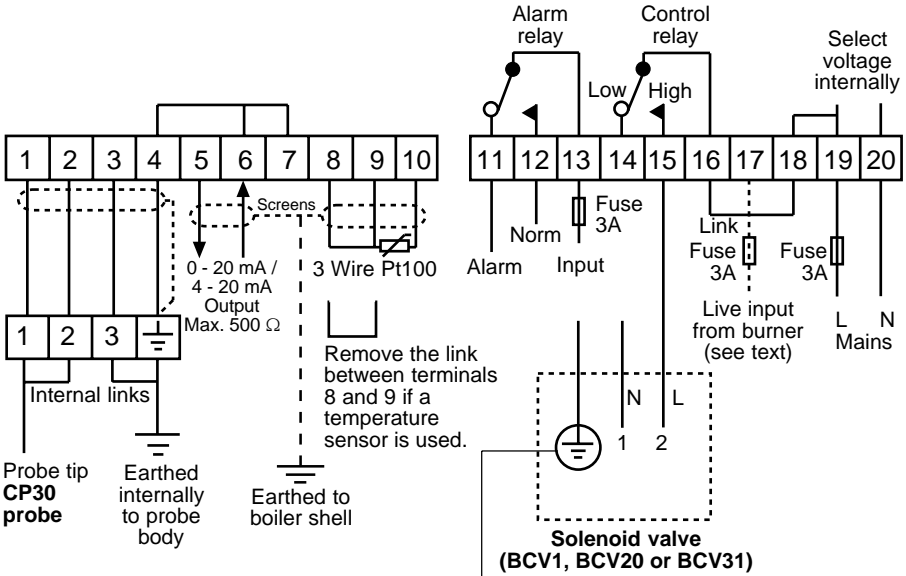

View of CP30 connector block removed from cable socket

**Note:** Protective earth must be connected in accordance with National regulations/codes.

**Notes:**

- Maximum cable length (probe to controller) 100 metres (328 ft). For CP10, see Section 6.4.3.
- Maximum resistance of 0-4/20 mA cable - 500 ohms - (negative is earthed to boiler at probe).
- All wiring materials and methods shall comply with EN and IEC standards where applicable.

Fig. 20

Fig. 20 continued

Ensure resistance from probe body to pipework/boiler shell is less than 1 Ω.

**Alternative wiring for CP10 probe**

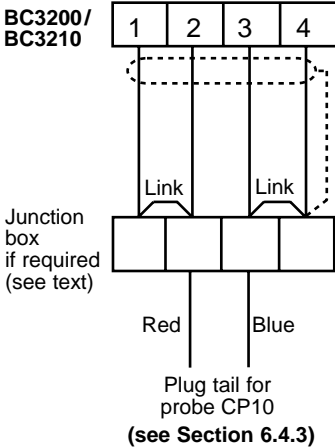

**Alternative wiring for UL version**

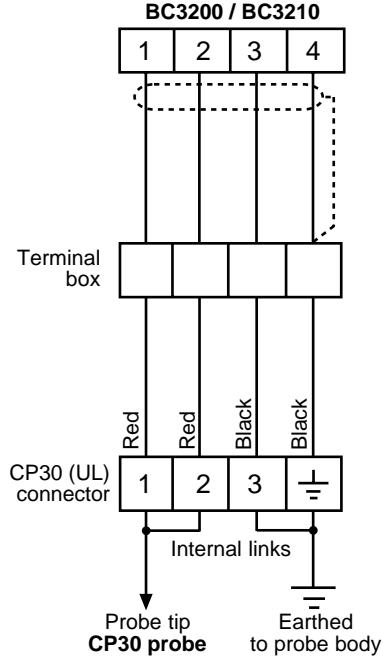

**6.1 Notes on the wiring diagram**

The mains / relay and sensor connector sockets **MUST NOT** be transposed; see Section 1 'General safety information'.

Recommended conductor size 1 mm<sup>2</sup> (18-16 AWG). The wiring connections are identified on the PCB, and further detail can be seen if the connector sockets are removed from the controller. Labels are provided for identification of the two connector sockets.

The wiring diagram is shown with the relays in the power off position.

A 3 amp quick blow external fuse must be fitted in all phases of the controller supply. A 1 amp quick blow external fuse must be fitted if the burner input is connected. The relays are rated at 250 V and must be on the same phase as the controller supply. Supply to the relays must be fitted with a suitably rated quick blow fuse for the following loads:

| Relay load type                         | Rating         |
|---|----------------|
| Lamp or resistive                       | 3 A            |
| Tungsten filament                       | 1 A            |
| ac motor @ 240 V                        | 1/4 HP (2.9 A) |
| ac motor @ 120 V                        | 1/10 HP (3 A)  |
| Control circuits and coils (Pilot duty) | C300 (2.5 A)   |

---

## 6.2 Screen connection

An earth current loop is created if a wire or screen is connected between two earth points, which are at different potential (voltage). If the instructions are followed correctly, then the probe screen will only be connected to the earth at one end.

**Note: The probe earth terminal is a functional earth rather than a protective earth.** A protective earth provides protection from electric shock under a single fault condition. This product has double insulation and therefore does not require a protective earth.

A functional earth is used in order for the product to operate. In this application, the earth (tank/boiler shell) is used as the common of the probe. It also provides a sink/drain for any electrical interference.

Ensure that the screen is connected to the earth terminal of the probe

Ensure that the common terminal of the controller is not internally earthed. (All Spirax Sarco boiler controls are internally isolated from earth).

**The common terminal of the controller must be earthed via the probe.**

### **CAUTION:**

**Do not connect the common terminal to an earth local to the controller. To do so may induce an earth current loop, which may reduce the performance or damage the product.**

## 6.3 Mains wiring

If different mains supplies are used for the controller power supply and the relays, ensure they are on the same phase.

The mains supply should normally be taken from the boiler panel after the control fuse. A separate mains supply may be used, but must be from the same phase, and fitted with a separate fuse (3 A).

**The controller additional live input from the burner (terminal 17) can be wired as follows:-**

1. Where the probe is fitted in the blowdown line, (intermittent flow), and a purge is required every 30 minutes irrespective of whether the burner has fired, connect the mains supply to terminals 19 (live) and 20 (neutral) as normal, and link terminals 17 and 18.
2. Where the probe is fitted in the blowdown line and a purge is required every 30 minutes of boiler firing (cumulative), connect a live supply from the burner control to terminal 17. This supply should be live whenever the burner is firing.
3. Where the probe is fitted in the boiler, or where there is continuous flow past the probe, no purge is required, so do not connect to terminal 17.  
Fit a link between terminals 16 and 18 to provide power to the control relay unless the controller is to be used for alarm only.

\* **Note:** Protective earth must be connected in accordance with National or Local regulations.

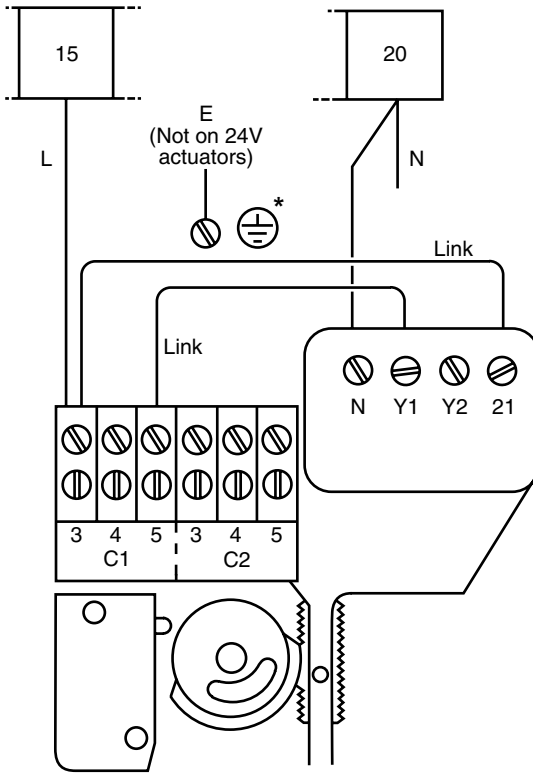

Fig. 21 230/115 Vac BCV30 blowdown valve wiring diagram

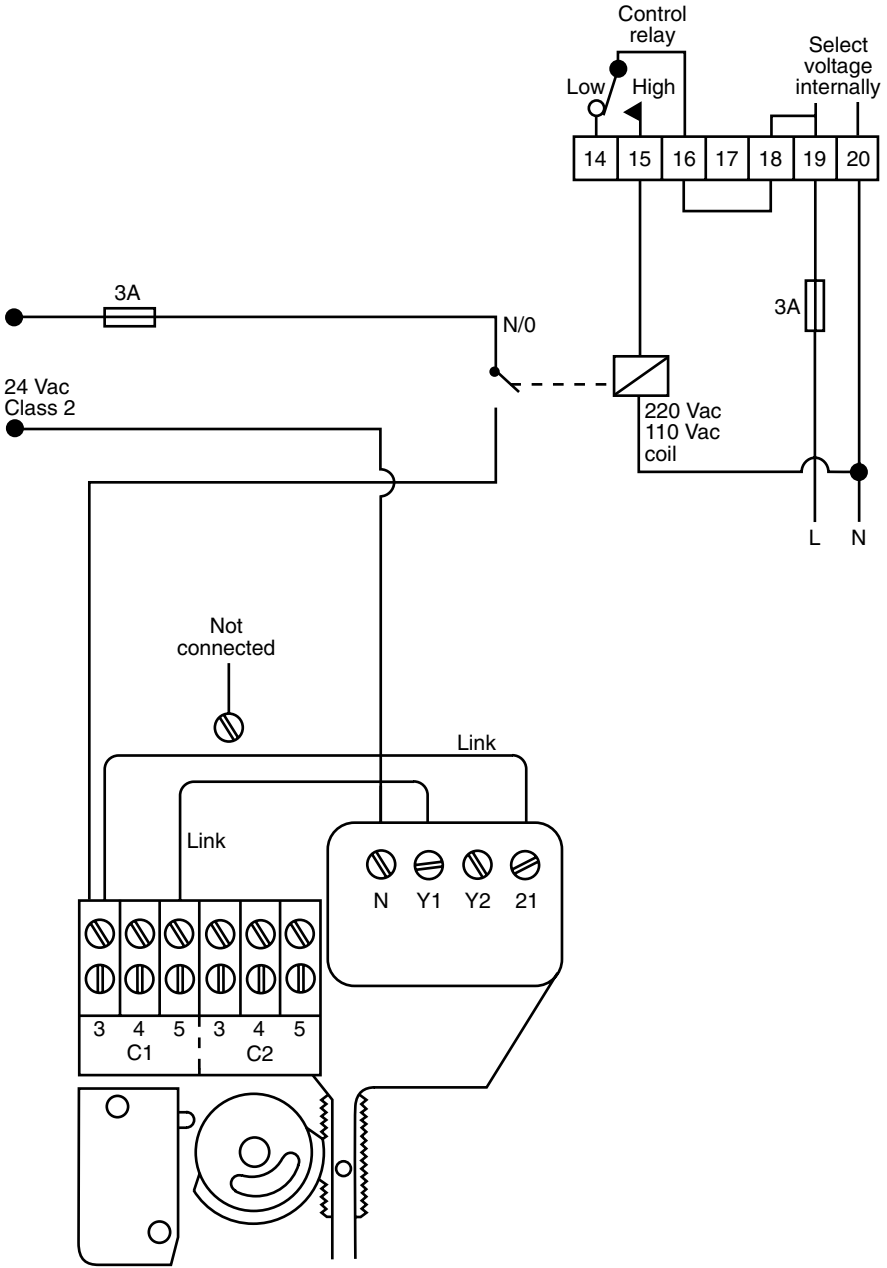

Fig. 22 UL 24 Vac BCV30 blowdown valve wiring diagram

## 6.4 Probe wiring

The maximum cable length for all probes is 100 m (328 ft). All cables must be of the same gauge.

### 6.4.1 Probe in boiler - CP30

The probe requires a 4 core screened cable connection.

Whilst pairs of conductors are linked at the probe, the four wire connection compensates for voltage drop along the cable. The CP30 UL recognised probe is supplied with four 18 AWG, 12" long colour coded flying leads. These are to be cut to length and wired to a suitable terminal block housed in a suitable metal box. A length of flexible metal conduit is required between the probe and the terminal box to provide environmental and impact protection, and easy electrical connection. The cable socket is provided with a ½" NPT conduit adaptor for this purpose. See CP30 IMI for further details.

### 6.4.2 Probe in boiler - CP32

The probe requires 8-way screened cable.

**Caution: Do not connect any wires to the 5-way terminal block, as it houses the very fine wiring from the probe which could be easily damaged in attempting to connect additional wires.**

### 6.4.3 Probe in blowdown (or condensate) line - CP10

For most applications the 1.25 m (4 ft) heat resisting probe cable will need to be extended using a junction box. If not, link terminals 1 to 2, and 3 to 4. Total maximum cable length 100 m (328 ft).

**Note:** Whilst pairs of conductors are linked at the junction box, the four wire connection is required to compensate for voltage drop.

### 6.4.4 Temperature probe wiring

If a temperature probe is to be used, remove the link between the controller terminals 8 and 9. A three or four wire Pt100 temperature probe may be used, but should be connected as a 3 wire probe. **Note:** For the TP20, when the cable is to be longer than the 1.25 m (4 ft) supplied, a junction box and 3 core screened cable will be needed.

Colour codes for sensor wires vary, but a three wire sensor will normally have 2 wires of one colour, and 1 wire of a different colour.

Connect the single wire to controller terminal 10, one of the same coloured wires to terminal 8 and the other to terminal 9.

A four wire sensor will have two wires one colour, and two wires of another colour.

Link one of the pairs at the junction box, and connect to terminal 10.

Connect one of the remaining two wires to terminal 8, and the other to terminal 9.

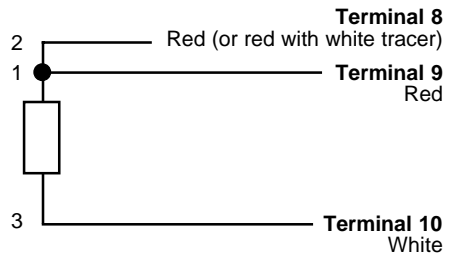
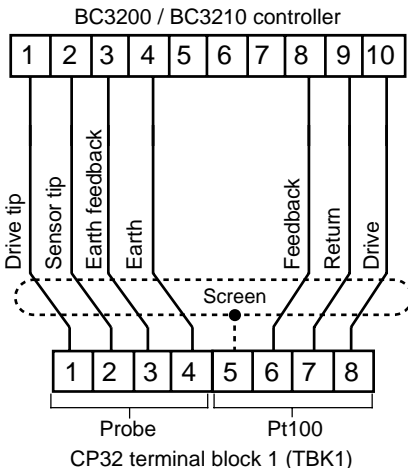

Fig. 23 CP32 probe wiring

Fig. 24 TP20 temperature probe

---

# 7. Commissioning

---

## 7.1 Familiarisation

**This section describes how the push buttons are used, and what the display read-out means.**

The controller is commissioned in much the same way as a digital watch, using the two push buttons on the front panel, marked '▲' and '▶'.

The '▲' button is used to step through the various options available, and also to change settings. The '▶' button is used to select settings that are to be changed. The '▶' button is also used to initiate a purge. See Section 7.1.7. The controller has a simple 'menu' system for setting the different functions. The items are organised as shown in Fig. 4, page 7, and are displayed by pressing the '▲' button. Setting is described in Section 7.2.

The controller has no battery. The programmed settings are held in nonvolatile memory (EEPROM), and are only written into memory 20 seconds after the last key stroke.

To ensure that any changes are retained in the memory, wait at least 20 seconds before switching off the mains supply to the controller.

### 7.1.1 Initial display - TDS

**Switch the controller on.** The display will show 'CLn' alternating at first with the TDS value, which will be '0000'. 'CLn' indicates that the controller is carrying out a probe conditioning cycle. It does this every time the controller is switched on if the 'CLn' time is not zero.

**Note:** The display will always show '0000' during a probe conditioning cycle when the controller is first switched on. Once the conditioning cycle has finished, the controller will show the actual TDS value. Once fully commissioned, The TDS value will alternate with 'bldn' when it is above the set point, with 'AL' when it is above the alarm level, and with 'PurG' when the system is carrying out a purge.

### 7.1.2 Range decimal point - 'rANG'

Press the '▲' button to display 'rANG', the range decimal point setting. The range must first be set using the internal function switch, then the decimal point added using the buttons. The decimal point must be selected before attempting to set any other controller parameters.

### 7.1.3 Set point - 'SP'

Following the diagram, press the '▲' button to step through the items on the menu.

The display will now show 'SP', set point.

This allows setting of the TDS value at which the controller will open the blowdown valve (or condensate dump valve).

You will find that the display changes after 20 seconds. If this happens during familiarisation, press the '▲' button until the required option reappears.

### 7.1.4 Hysteresis - 'HSt'

Press the '▲' button.

The display will show 'HSt'. This is the set point hysteresis setting, an adjustable damping effect which stops the blowdown valve from being switched over-frequently by fluctuations in TDS level due to water circulation.

Press the '▲' button.

### 7.1.5 Alarm - 'AL'

'AL', the alarm setting mode, will be displayed.

The alarm is always set above the set point, and would be used to warn of a very high TDS level.

The alarm has a fixed hysteresis of 3%.

### 7.1.6 Calibration - 'CAL'

Press the '▲' button.

'CAL' will be displayed. This is the calibration setting, which is used to match the controller to the TDS level in the boiler.

To calibrate the controller, a sample of boiler water is taken and its TDS level found with a conductivity meter such as the Spirax Sarco MS1. **The minimum conductivity is 10 µS/cm or 10 ppm.**

---

### 7.1.7 Purge - 'PurG'

'PurG' is the next mode to be displayed. It is used only when the probe is mounted in the blowdown line, and ensures the sensor measures the TDS at boiler temperature. The time varies for different installations, and is adjustable from 0 - 99 seconds or 0 - 0.99 of an hour. See Section 7.2.6c 'Purge time', page 23. The purge time is set to zero if the probe is installed in the boiler.

If the purge time is set to any figure other than zero, the controller will automatically limit the cleaning (conditioning) time to 9 seconds (max.) to avoid bubbles forming on the probe during the purge, and causing an inaccurate reading.

### 7.1.8 Probe conditioning cycle - 'CLn'

Press the '▲' button.

The display will show 'CLn', the probe cleaning/conditioning facility mentioned in Section 2, 'General product information'. This operates every 12 hours for an adjustable period of 0 - 99 seconds for boiler-mounted probes, or 0 - 9 seconds for probes mounted in the pipeline.

It uses an electrical current to restore conductivity to a TDS probe that has become scaled due to less than ideal water treatment, and though extremely useful, must not be regarded as a substitute for good water treatment.

If a probe is becoming scaled, (indicated by a need for increasingly frequent recalibration), then scale will also be forming in the boiler. Consult a competent water treatment specialist.

### 7.1.9 Filter - 'Filt'

Press the '▲' button.

The 'Filt' mode is only used when the probe is fitted directly in the boiler, and is recommended to increase the damping effect, avoiding over-frequent switching of the blowdown valve. With the filter on, the controller display will take longer to stabilise when the unit is switched on. Typically, it will be within 1% of its final reading after 5 minutes.

### 7.1.10 Setting 0/4 - 20 mA

Press the '▲' button.

'0 - 20' or '4 - 20' will now appear on the display, the selectable output range in mA. It may be changed if required. Note that 4 mA (0 mA) = 0, 20 mA = top of scale selected, e.g. 99.90, 999.0, 9990.

### 7.1.11 Probe - 'PrbE'

Press the '▲' button.

'PrbE', probe mode, is only used with a 2-tip probe, and sets the action to be taken by the controller on detecting a fouled probe.

Press the '▲' button again to return to the start of the menu.

The display will show the TDS value once more.

If the TDS value is high enough to open the blowdown valve, the display will alternate with the 'bldn' message. Similarly, if the alarm value has been reached, the display will alternate between the TDS figure and 'AL'.

## 7.2 Commissioning the controller

Once familiar with the way in which the controller operates, actual commissioning may be carried out. If the display changes during commissioning (after 20 seconds), press the '▲' button until the required option reappears.

### 7.2.1 Range decimal point

The range is set using the internal range switches.

Select 'rANG' and use the buttons to position the decimal point. The range decimal point must be selected before attempting to set any other controller parameters.

Position the decimal point as follows:-

| Range selected on internal switch | Position of decimal point |
|-----------------------------------|---------------------------|
| 10 - 99                           | 00.00                     |
| 100 - 999                         | 000.0                     |
| 1000 - 9990                       | 0000                      |

---

## 7.2.2 Set point

The set point is the TDS value at which the blowdown or dump valve will open. The boiler manufacturer should be consulted wherever possible to specify the most suitable value.

Switch on the controller, and press the '▲' button until 'SP' appears.

Press the '▶' button. Four figures will appear, with the first one flashing.

Use the '▲' button to change the first figure, then press the '▶' button.

The second figure will flash.

Use the '▲' button again to change the second figure, and repeat the operation for the third figure, using the '▲' button to change it, and the '▶' button to step to the next figure.

### Notes:

The fourth figure is always zero and cannot be changed:

- If one or more of the figures is already showing the correct value, press the '▶' button to accept it.
- If the controller is only being used to provide an alarm, set the 'SP' reading to 9990.

## 7.2.3 Hysteresis

This is normally set to 5% of the set point value, though it can be increased to 10% or more if the valve is found to be operating over-frequently.

### Example:

Set point = 3000  $\mu\text{S}/\text{cm}$

Hysteresis (5% of set point) = 150  $\mu\text{S}/\text{cm}$

The controller will open the valve at the set point of 3000  $\mu\text{S}/\text{cm}$ , and will close the valve at 2850  $\mu\text{S}/\text{cm}$ .

Press the '▲' button until 'HST' appears.

Press the '▶' button to display four figures, with the first one flashing.

Use the '▲' button to change the first figure and the '▶' button to step to the next figure.

## 7.2.4 Alarm

The alarm TDS level is set in accordance with the boiler manufacturers recommendations, and must be above the set point level. Press the '▲' button to select 'AL', then the '▶' button to display a four figure display, with the first figure flashing.

Use the '▲' button to change the figures, and the '▶' button to step to the next figure.

If the alarm is not used, set the 'AL' reading to 9990.

## 7.2.5 Notes on calibration

The boiler must be at working temperature when calibrating a system. This particularly important if a temperature sensor is not fitted.

**If the 'CAL' setting is selected again after calibrating the controller, the controller will display a figure different to the one expected. This figure is used as part of the diagnostic procedure (described in Section 9, 'Fault finding').**

To ensure accuracy, the figures entered for both Set Point and Calibration must be greater than 10% of the chosen range. For the best accuracy, calibrate the controller with the TDS as close as possible to the Set Point. In some cases the boiler may need to be run for a period of time to allow the TDS to build up before calibration.

Recalibrate the boiler at the Set Point once the boiler has settled down (after a few days in most cases). Check the calibration (as close to the Set Point as is practical) weekly to ensure optimum performance.

## 7.2.6 Calibration

### a) Probe in boiler

The controller now needs to be set to give an accurate reading of the actual TDS level in the boiler. Allow the previous reading to stabilise for 30 seconds (5 minutes if filter is ON - see Section 7.1.9, 'Filter - Filt', page 21) before calibration.

Take a sample of the boiler water and measure its conductivity using a meter such as the Spirax Sarco MS1.

Press the '▲' button to select 'CAL', then use the '▲' and '▶' buttons to set the controller display to the boiler TDS level.

Press the '▶' button again to return to the TDS display.

## b) Probe in blowdown line

The controller now needs to be set to give an accurate reading of the actual TDS level in the boiler. To do this, the blowdown valve must be opened (purged) to allow water to pass the sensor at boiler temperature.

Take a sample of the boiler water and measure its conductivity using a meter such as the Spirax Sarco MS1.

Allow the controller display to stabilise for 5 minutes.

Press the '▲' button until 'PurG' is displayed, and select 0.10 hours (six minutes). This allows maximum time for the pipeline and sensor to reach boiler temperature. The purge time is readjusted after calibration.

Press the '▶' button to start the purge.

Wait for 5 minutes to allow the pipeline to reach the same temperature as the boiler, then press the '▲' button to select 'CAL' on the display.

Use the '▲' and '▶' buttons to set the controller display to the boiler TDS level.

**Note:** Calibrate the controller while the purge is taking place if possible, or within a few minutes of it finishing for the most accurate setting.

## c) Purge time

Once the system has been calibrated, reset the purge time to the minimum time that will allow the display to stabilise.

Where the probe is installed in the blowdown line, as on BCS1 and BCS4 systems, 30 seconds is normally sufficient time to ensure the sensor reaches boiler temperature. Where a slow-opening valve is used, or where there is long or large bore pipework between the boiler and the sensor, a longer purge time will be required.

To find the best purge time:

- Allow the blowdown pipework to cool for 15 minutes.
- Press the '▶' button to start a purge, and note the time taken for the display to stabilise.
- Set this time as the purge time.

**Note:** When the purge time is set to anything other than zero, the display is only updated when the blowdown valve is open. This means that when the controller is switched on after the 'CLn' time, the display will show '0000' until the next purge. To update the display, either press '▶' to start a purge, or set the 'PurG' time to zero.

If the display does not stabilise, set 'PurG' to 0.10 hours (6 minutes) and repeat.

Note that the time between purges is either every 30 minutes, or every 30 minutes of boiler firing

- wiring details given on page 14.

## 7.2.7 Probe conditioning time

The probe conditioning circuit operates automatically every 12 hours, and also whenever the unit is switched on.

Thus, a 'manual' probe conditioning cycle can be carried out if required by switching the controller off, then on again. The duration of the conditioning cycle is adjustable up to 99 seconds (Note - limited to 9 seconds if a purge time is set), but a typical setting would be 20 seconds, increasing if scaling on the probe (and in the boiler) were causing frequent recalibration to be needed.

Set the duration to zero if the feature is not required.

Select 'CLn' and use the buttons to adjust the duration.

## 7.2.8 Filter

The filter is automatically set to 'OFF' by the software if 'PurG' is set to any figure other than zero, as when the probe is installed in the blowdown line.

If the probe is installed directly in the boiler, select 'Filt', then ON. This will increase the damping effect on the probe output, helping to stabilise the display against boiler water TDS fluctuations.

## 7.2.9 0 - 20 or 4 - 20 mA

This sets the controller output to suit the two current loop standards in common use. Press the '▲' button to select (note that the display may show either setting), and the '▶' button to set the display flashing, and the '▲' button to change from 4 - 20 mA to 0 - 20 mA or vice versa.

---

### 7.2.10 Probe scale detect feature

This feature is only available when a two-tip probe is installed.

It selects the action taken by the controller to a probe with too high a resistance, caused, for example, by scaling.

Select 'PrbE', then press the '➔' button to select one of the following:-

'0' No action. (This setting is also selected where a single tip probe is used).

'1' If the probe is scaled then the interval between probe conditioning cycles will change from 12 hours to just over 10 minutes, until the probe is clean. The display flashes 'Cln' during the conditioning cycle.

'2' Alarm relay released, and the display will show 'Flt 1'. The display can be cleared by pressing either button.

'3' Recommended setting - alarm relay released, display shows 'Flt 1', and probe conditioning circuit is activated as in '1'.

'Flt 1' is only displayed during the conditioning cycle.

Caution: The probe may be damaged if 'cleaning every 10 minutes' is allowed to continue for long periods.

At setting '3', the alarm will be active if the probe becomes scaled.

The probe should be examined and mechanically cleaned after 12 hours of 'fault condition'.

**Note:** Certain probe or wiring faults will also trigger the probe scale detect feature.

---

## 8. Maintenance

---

No special servicing or maintenance of the controller is necessary.

In many countries, including the UK, legal regulations are in force concerning boiler blowdown. In particular, attention is drawn to the danger of working on a shut-down boiler while other boilers are operating. General guidance for the UK is given in Health and Safety Executive Guidance Note PM60.

### Available spares

|                                    |                      |            |
|------------------------------------|----------------------|------------|
| Spare fuses                        | Stock number 4033380 | (set of 3) |
| BC3200/BC3210 display PCB assembly | Stock number 4033481 |            |

### To fit a new display PCB assembly:

**Warning:** Read the safety precautions, Section 1, before attempting to dismantle the unit.

This component must be fitted by a competent electrical engineer.

The assembly contains a micro-controller and other components which may be permanently damaged by failure to observe anti-static precautions.

- Remove the front panel\*
- Disconnect ribbon cable between display PCB and main PCB.
- Remove the retaining screws and the display PCB.
- Fit the new assembly and retaining screws.
- Refit the ribbon cable.
- Refit the front panel.

**\* Note:**

The BC3200 front panel is held in place by four visible screws.

The current BC3210 front panel is held in place by four screws underneath the front panel label. Lift the corners of the label carefully to expose the screws.

Earlier BC3210 front panels were held in place with an adhesive gasket only. Use a screwdriver to gently lift the front panel forwards.

# 9. Fault finding

Problems experienced during commissioning are often found to be due to incorrect wiring or setting up, so we recommend that a thorough check is first carried out for such faults as:

- Neutral not connected.
- Check that there is a wire link fitted between terminals 8 and 9 if a temperature sensor is not used.

Malfunctions during service can be due to a build-up of scale on the probe, usually caused by inadequate water treatment. **Note:** If this is the case, scale will also be present in the boiler, and a competent water treatment company should be consulted to avoid the possibility of serious boiler damage.

## 9.1 Testing the controller

### WARNING

**Disconnect the mains power supply before preparing the controller for these tests.**

A simple test can be made on the controller even when the boiler is shut-down or empty:

- Ensure that a link is fitted between controller terminals 8 and 9 if a temperature sensor is not fitted.
- Unplug/unscrew the connector from the conductivity probe and connect it to a Spirax Sarco APS1 probe simulator.
- Use the Table below to select a resistance on the APS1 appropriate to the controller range setting. (For example, if the range is 1000 - 9990, select '22  $\Omega$ ' on the APS1.) It should then be possible to calibrate the controller to a half scale reading if it is functioning correctly.

If an APS1 is not available, it is still possible to carry out a test:-  
Check that controller terminals 8 and 9 are linked. Select a resistor value from the Table below appropriate to the controller range. (For example, if the range is 100 - 999, fit a 220 ohm resistor.

Connect the resistor and links as shown in Fig. 25:-

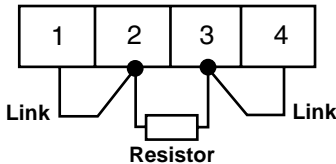

Fig. 25

If the controller is functioning correctly it should then be possible to calibrate it to half scale reading.

| Controller range (ppm or $\mu\text{S/cm}$ ) | Half scale | Resistance (Ohms) |
|---|------------|-------------------|
| 10 - 99                                     | 50         | 2200              |
| 100 - 999                                   | 500        | 220               |
| 1000 - 9990                                 | 5000       | 22                |

## 9.2 Diagnostic features

The controller has several features which can be used as an aid to fault diagnosis.

1. If a two-tip probe is fitted, the controller can be programmed to automatically start an extended probe cleaning (conditioning) cycle on detection of scaling, as well as to sound an alarm and display a fault code. 'Flt 1' This is described in Section 9, 'Commissioning'.
2. A decimal point will appear in front of the 'PurG' display if the burner input is live, i.e. the burner is on.
3. A decimal point will also appear in front of the 'CLn' display if a probe fault occurs.
4. The controller will display 'Flt 2' if any of the settings have become corrupted, and will instead use the following default, or 'emergency' settings:-

|                  |      |                    |           |
|------------------|------|--------------------|-----------|
| 'CLn' and 'PurG' | 0    | 'CAL'              | 3000      |
| 'SP'             | 3000 | Output             | 4 - 20 mA |
| 'HSt'            | 300  | 'Filt'             | OFF       |
| 'AL'             | 5000 | Probe scale detect | 0         |

## 9.3 Checking the probe condition

The probe condition can be checked without removing it from the boiler.

The figure shown on the display when 'CAL' is selected can be used to calculate an approximation of the probe cell constant, an indication of probe condition. We will call this figure the probe factor:- Press the '▲' button to display 'CAL' then the '▶' button to display a figure.

860 divided by this figure gives the probe factor, which should be between 0.2 and 0.6, with range decimal point set to 9990.

Ignore the decimal point for other settings.

**Examples:-**

'CAL' is 2370.

$$\frac{860}{2370} = 0.363$$

Probe factor of 0.363 indicates that the probe is in good condition. A lower probe factor represents a more conductive probe.

'CAL' is 1070.

$$\frac{860}{1070} = 0.804$$

Probe factor of 0.804 is too high, indicating a scaled probe.

**Notes**

**If temperature compensation is not fitted, the probe factor range will be wider. See below:-**

|                                    |                          | Acceptable probe factor |
|------------------------------------|--------------------------|-------------------------|
| Temperature compensation fitted    |                          | 0.20 - 0.6              |
|                                    | 100°C boiler temperature | 0.40 - 1.1              |
| No temperature compensation fitted | 150°C boiler temperature | 0.30 - 0.8              |
|                                    | 200°C boiler temperature | 0.20 - 0.6              |
|                                    | 238°C boiler temperature | 0.18 - 0.5              |

---

### **Upper limit**

The upper limit for the 'CAL' display is 8190. If this is approached it is probably because:

- Wiring is incorrect:- possible short circuit.
- Function switches incorrectly set.
- No link fitted between terminals 8 and 9 when temperature compensation is not used.
- Low resistance through water (CP30 probe tip shroud missing).
- Probe tip shorted.

### **Lower limit**

The lower limit for the 'CAL' display is 480. If this figure is approached it is probably because of:

- Incorrect wiring:- possible open circuit.
- Function switches set incorrectly.
- Probe scaled.

**If either of these limits are reached it will not be possible to calibrate the controller to the required value.**

## **9.4 Controller display remains at zero (0000) after the controller is powered up**

This is normal when a purge (PurG) time other than zero is set, as the display is only updated when the blowdown valve is open.

This means that when the controller is switched on, after the 'clean' (Cln) time, the display will show '0000' until the next purge.

### **To update the display, either:**

- Press the '▶' button to start the purge or, if the probe is in the boiler.
- Set the purge time to zero.

# — 10. Appendix - CCD applications —

## Condensate contamination detection applications

### 10.1 Scope

This appendix brings together those points in the main body of the IMI concerning the use of the controller in a condensate contamination detection (CCD) system, and contains extra information and diagrams. It is still necessary to read the main part of the IMI. The minimum practical Set Point is 10  $\mu\text{s}/\text{cm}$  or 10 ppm.

### 10.2 System description

**Note:- Most countries have regulations that limit temperature and contamination levels for fluids being dumped to drain. It is also essential to follow guidelines issued by bodies such as the UK Health and Safety Executive.**

The Spirax Sarco CCD system monitors and displays the conductivity of condensate return, and will redirect the flow to drain if the conductivity increases above a pre-set level to avoid contaminated water being returned to the boiler feedtank.

It will not detect contaminants that do not change the conductivity, such as oils, fats, or sugars. A conductivity sensor and a temperature sensor are mounted in a bypass line as shown in Fig. 26. A check valve in the main line ensures a flow past the sensor under low flow conditions. The 500 mm head prevents flash steam flow in the bypass line.

We recommend a 3-port diverter valve such as the Spirax Sarco QL. A spring retract pneumatic actuator is normally fitted to cause the valve to divert on failure of the air supply.

Alternatively, two 2-port valves (M20, for example) may be used as shown in Fig. 27, one as a spring-to-close isolating valve in the condensate return line, and one as a spring-to-open dump valve, in the drain line.

On detection of high conductivity, the isolating valve closes and the dump valve opens, both under spring pressure.

Suitable 3-port solenoid valves may be selected from the Spirax Sarco range, and are described in separate literature.

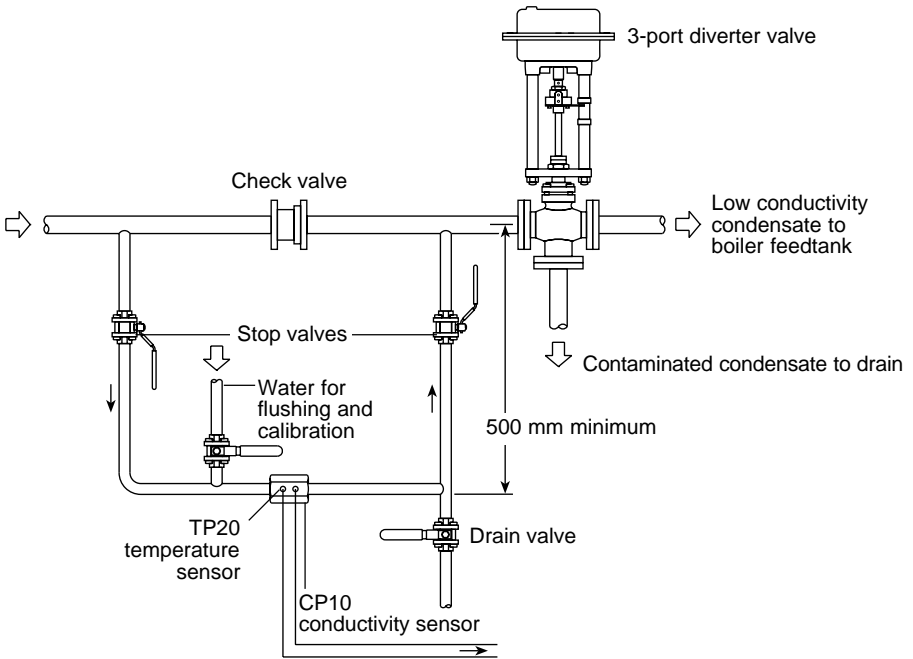

**Fig. 26 System with 3-port spring-to-divert valve**

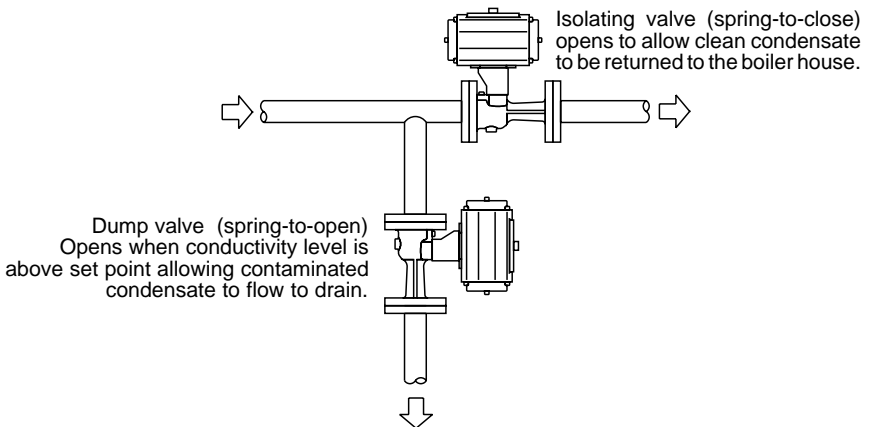

**Fig. 27 Alternative arrangement using separate valves**



## 10.4 Function switch settings

Fig. 28 shows the function switch set for a CCD system using a CP10 sensor. Note that switch 8, the security option, can be ON or OFF.

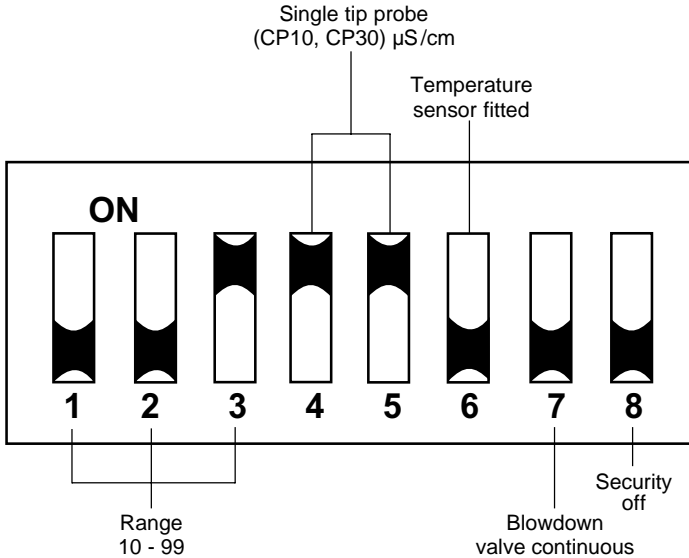

Fig. 28 CCD function switch settings

### 10.4.1 Range - switches 1, 2, and 3

The lowest controller range, 10 - 99, is normally selected for condensate monitoring duties. Set switches as follows:-

| Switch | Position |
|--------|----------|
| 1      | OFF      |
| 2      | OFF      |
| 3      | ON       |

### 10.4.2 ppm or $\mu\text{S}/\text{cm}$ - switch 4

Conductivity is measured in  $\mu\text{S}/\text{cm}$ , so set switch 4 to ON.

### 10.4.3 Probe type - switch 5

Set switch 5 to ON, single tip probe.

### 10.4.4 Temperature compensation - switch 6

Temperature compensation is required as temperatures in the system can vary widely, so set switch 6 to OFF.

### 10.4.5 Valve operation - switch 7

Intermittent valve operation is not required, so set switch 7 to OFF.

### 10.4.6 Security feature - switch 8

Set switch to OFF to allow any of the parameters to be set or changed.

With switch ON, calibration only can be changed, though other settings can still be viewed.

---

## 10.5 Commissioning

Read the main section on familiarisation before commissioning the system for the first time. Commissioning is carried out as detailed in the main section of the IMI, apart from the following points:-

### 10.5.1 Set point

This is the conductivity level at which the valve(s) diverts the condensate to drain.

We recommend that a competent water treatment company is consulted to establish the most suitable conductivity level for individual plant. Conditions vary widely, as do the chemical properties and conductivity of contaminants.

In many cases, the normal measured value of 'clean' condensate will be very low, perhaps only 1 or 2  $\mu\text{S}/\text{cm}$  in some cases, whereas the set point may be much higher, perhaps 30 or 40  $\mu\text{S}/\text{cm}$ . Entering the set point is described in the main body of the IMI.

### 10.5.2 Hysteresis

Select a larger value, of perhaps 10  $\mu\text{S}/\text{cm}$ , to avoid the possibility of the dump valve operating over-frequently.

### 10.5.3 Alarm

Though the alarm conductivity level must be higher than the set point, it can be set quite close to it if required, so that there is little difference in conductivity between the condensate being diverted to drain, and the alarm operating.

## 10.6 Calibration

**Note:** Normal working conductivity may be very low (1 or 2  $\mu\text{S}/\text{cm}$ ).

To calibrate a CCD system, a liquid at approximately the maximum allowable conductivity is introduced into the system. This conductivity figure (the set point) must be greater than 10  $\mu\text{S}/\text{cm}$ .

Use a mixture of tap water and condensate, to simulate condensate at approximately the maximum allowable conductivity level (the set point). 5 litres (1.3 US gallons) will be plenty for most systems. Use the Spirax Sarco MS1 conductivity meter to check the conductivity.

Close both stop valves (Fig. 26) and open the drain valve and 'water for flushing and calibration' valve.

Pour in the prepared water, and let it run through the system until bubble free.

Close the drain valve.

Allow the display to settle for two minutes.

Select 'CAL' and set the display to the conductivity level as described in the main text (Section 7.2.6).

It is advisable to check calibration after the system has been running for a few days, then periodically depending on the individual plant conditions. Consult your water treatment specialist if in any doubt.

### 10.6.1 Range decimal point

Section 7.1.2.

### 10.6.2 Probe conditioning time

Section 7.2.7.

### 10.6.3 Purge time

Set this to zero for CCD purposes.

### 10.6.4 Filter

This is normally set to OFF, for fast system response. If the conductivity level is seen to change very rapidly during normal operation, then set the feature to ON to give a delayed response.

### 10.6.5 0 - 20 or 4 - 20 mA

The 0 / 4 - 20 mA output from the controller may be wired to a Building Management System, a remote display, or a computer (terminals 5 and 6).

### 10.6.6 Probe scale detect feature

Not applicable, so set to '0'.