

BC3100 Controller

Installation and Maintenance Instructions

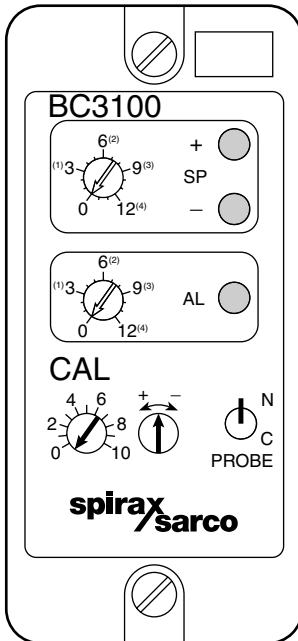

1. *General safety information*
2. *General product information*
3. *Installation*
4. *Setting up the controller*
5. *Wiring diagram*
6. *Commissioning*
7. *Operation*
8. *Maintenance*
9. *Fault finding*



1. General safety information

Your attention is drawn to Safety Information Sheet IM-GCM-10 as well as to any National or local regulations.

Safe operation of the product depends on it being properly installed, commissioned and maintained by a qualified person in compliance with the operating instructions.

It is essential to comply with general installation and safety instructions for pipeline and plant construction, as well as to make proper use of tools and safety equipment.

The product is designed and constructed to withstand the forces encountered during normal use. Use of the product for any other purpose, or failure to install the product in accordance with these Installation and Maintenance Instructions, could cause damage to the product, will invalidate the CE marking, and may cause injury or fatality to personnel.

Warning

Isolate the mains supply before unplugging the controller since hazardous voltages will be exposed on the controller base. This product complies with the requirements of Electromagnetic Compatibility Directive 89/336/EEC by meeting the standards of:

- BS EN 50081-1 (Emissions) and

The following conditions should be avoided as they may create interference above the limits specified in BS EN 50082-1 (Immunity):

- The product or its wiring is located near a radio transmitter.
- Excessive electrical noise occurs on the mains supply. Power line protectors (ac) should be installed if mains supply noise is likely. Protectors can combine filtering, suppression, surge and spike arrestors.
- Cellular telephones and mobile radios may cause interference if used within approximately 1 metre (39") of the product or its wiring. The actual separation distance necessary will vary according to the surroundings of the installation and the power of the transmitter.

If this product is not used in the manner specified by this IMI, then the protection provided may be impaired.

2. General product information

The BC3100 controller is used in conjunction with Spirax Sarco conductivity probes to monitor and control the concentration of total dissolved solids (TDS) in steam boilers, and for applications such as feedwater conductivity monitoring and condensate contamination detection. The minimum conductivity is 10 $\mu\text{S}/\text{cm}$ or 10 ppm.

The input voltage setting, conductivity and other parameters are selected by internal switches on installation. See Section 4 'Setting up the controller', page 6.

The BC3100 can be calibrated in ppm or $\mu\text{S}/\text{cm}$, and configuration labels are provided for the controller front panel and enclosure chassis plate for easy identification of the selected range.

An adjustable high TDS alarm with relay output are provided as standard.

The controller also has a manually switched probe cleaning circuit, (UK Patent No. 2276943), which enables the system to maintain its accuracy even when inadequate water treatment is causing some boiler and probe scaling to occur.

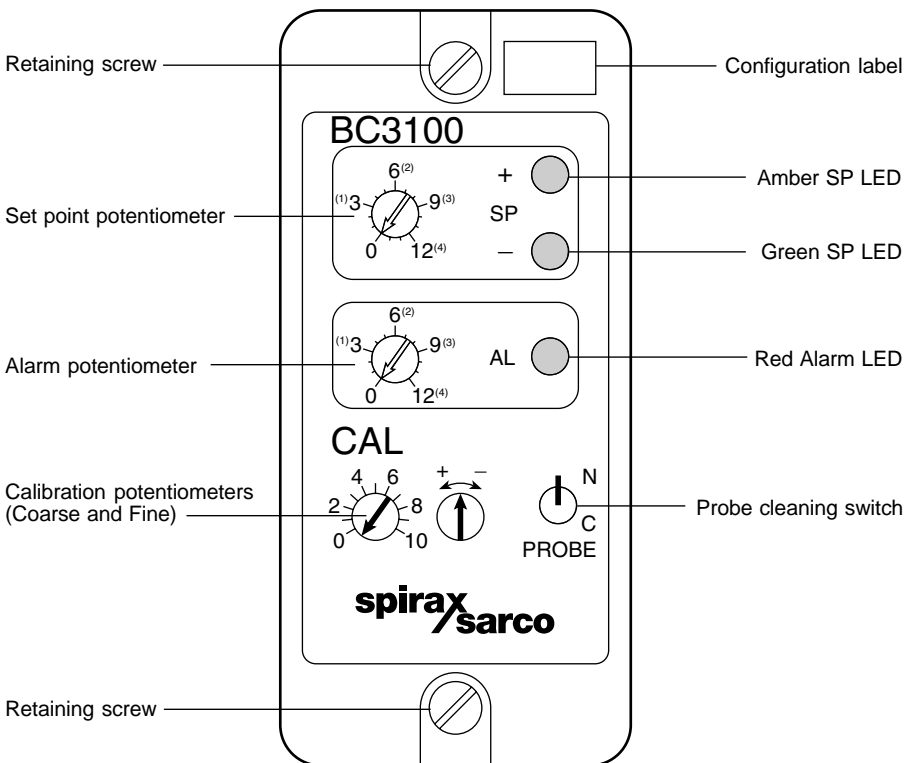

Fig. 1

3. Installation

WARNING:

Isolate the mains supply before unplugging the controller since hazardous voltages will be exposed on the controller base.

To unplug the controller from its base, undo the two retaining screws and pull the controller straight forwards. Rocking the controller in the vertical plane will ease removal.

The controller must be installed in a suitable industrial control panel or enclosure to provide environmental protection (pollution degree 2). Spirax Sarco can provide suitable enclosures.

The controller may be mounted on a 'top hat' DIN rail using the clip provided or the clip can be removed and the controller base screwed directly to a chassis plate.

Caution: Allow 15 mm (5/8") spacing between multiple units for air circulation.

The controller is for installation category II (Overvoltage category) and must be installed in accordance with IEC 60364 or equivalent. The controller and all connected circuits must have a common isolation system which meets the relevant requirements of IEC 60947-1 and IEC 60947-3 or equivalent. This must be positioned close to the controller and clearly identified as the disconnect device.

A quick blow 3 amp external fuse must be fitted in all phases of the controller and relay supply. The relays are rated at 250 Vac and must be on the same phase as the controller supply

Note:- The wiring diagram (Section 5) show all relays in the power off position.

Screened cable is required for the probe. A suitable cable is Pirelli FP200 or Delta Crompton OHLS, 1 mm² 2 core. The same cable may be used for the mains wiring. For maximum probe cable lengths see 'Notes on the wiring diagram', Section 5.1.

Connect the screens as shown in the wiring diagram (Section 5). Cabling should be installed in accordance with BS 6739 - Instrumentation in Process Control Systems: Installation design and practice or local equivalent.

If the product is not used in the manner specified in this IMI, then the protection provided may be impaired.

Technical data

Maximum ambient temperature	55°C	(131°F)
Minimum ambient temperature	0°C	(32°F)
Over voltage category	II	
Indoor use only		
Altitude up to	2000 m	(6561 ft)
Humidity	Maximum relative humidity 80% for temperatures up to 31°C (87.8°F) decreasing linearly to 50% relative humidity at 40°C (104°F).	
Protection rating	IP40	
Maximum cable length (controller to probe)	see Table in Section 5.1	
Minimum conductivity	10 μS/cm or 10 ppm	
Mains supply voltage	230 V setting	198 V - 264 V
	115 V setting	99 V - 132 V
Frequency	50 - 60 Hz	
Maximum power consumption	6 VA	
Fuse type	20 mm Cartridge, 100 mA anti-surge (T)	
Maximum 0/4 - 20 mA output load	500 Ω	

4. Setting up the controller

4.1 Setting up the controller

The controller is supplied set up as follows:

- 230 V mains supply.
- 4 000 - 12 000 $\mu\text{S}/\text{cm}$.
- No Pt100.
- 4 - 20 mA output.

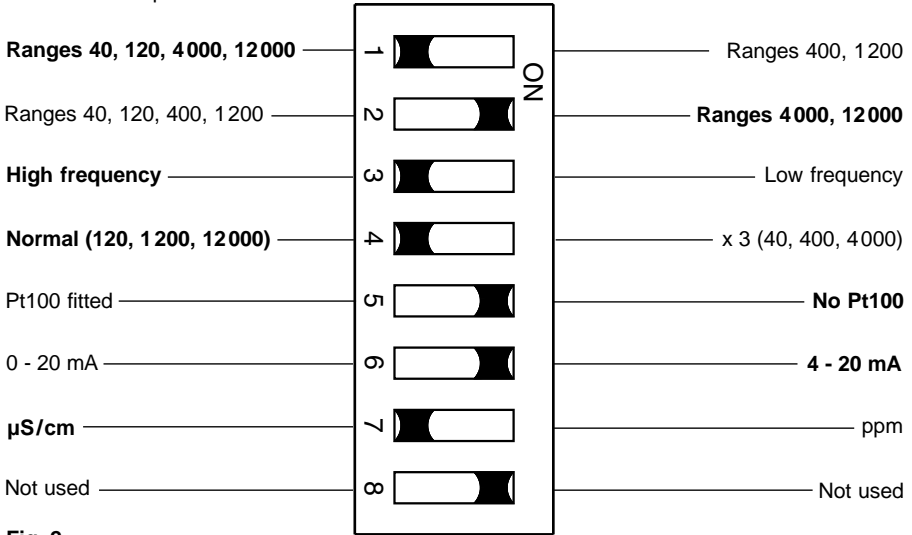

Fig. 2

4.2 To change the mains supply voltage:

- Loosen the two clamping screws.
- Unplug the controller from its base.
- Remove the rear cover panel.
- Slide out the printed circuit board assembly.
- Move the voltage selector switch to the 115 V setting.
- Replace the printed circuit board assembly.
- Replace the rear cover panel.
- Plug the controller into its base.
- Tighten the cover screws.

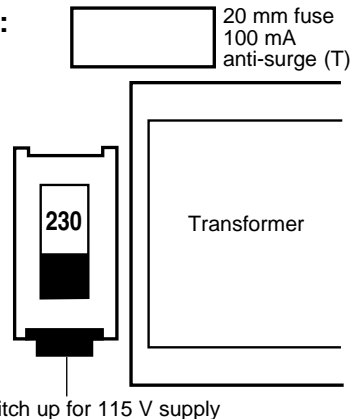
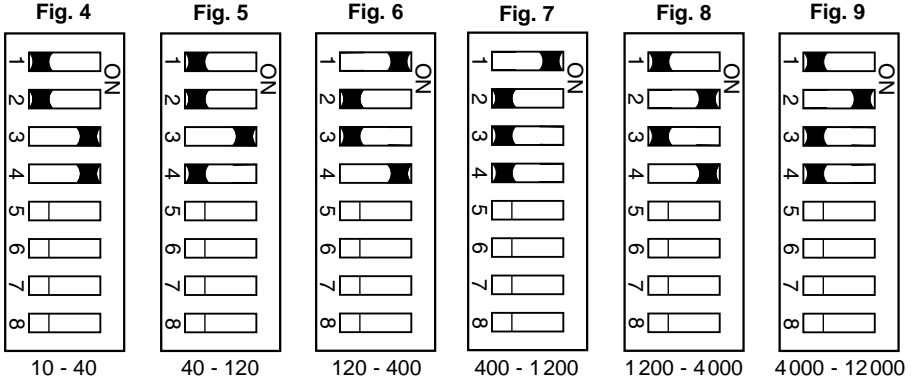

Fig. 3

4.3 To change the controller range:

- Loosen the two cover retaining screws.
- Unplug the controller from its base.
- Remove the rear cover panel.
- Slide out the printed circuit board assembly.
- Select required range in $\mu\text{S}/\text{cm}$ or ppm by setting switches 1 to 4 as shown in Figures 4 - 9.
- Replace the printed circuit board assembly.
- Replace the rear cover panel.
- Plug the controller into its base.
- Tighten the cover retaining screws.



4.4 To change other settings:

- Loosen the two cover retaining screws.
- Unplug the controller from its base.
- Remove the rear cover panel.
- Slide out the printed circuit board assembly.
- Select required functions by setting switches 5, 6 and 7 as shown in Figure 10.
- Replace the printed circuit board assembly.
- Replace the rear cover panel.
- Plug the controller into its base.
- Tighten the cover retaining screws.

Note: switch 8 is not used.

A Pt100 temperature sensor is required if the controller is used for condensate monitoring, or for boilers where the working pressure varies significantly. Set switch 5 to OFF if a sensor is to be used.

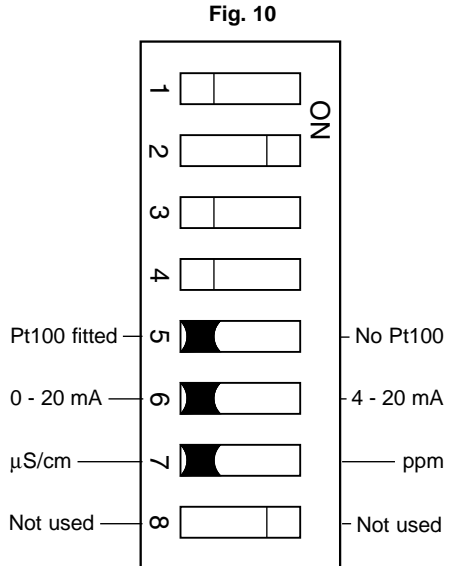

5. Wiring diagram

Fig. 11

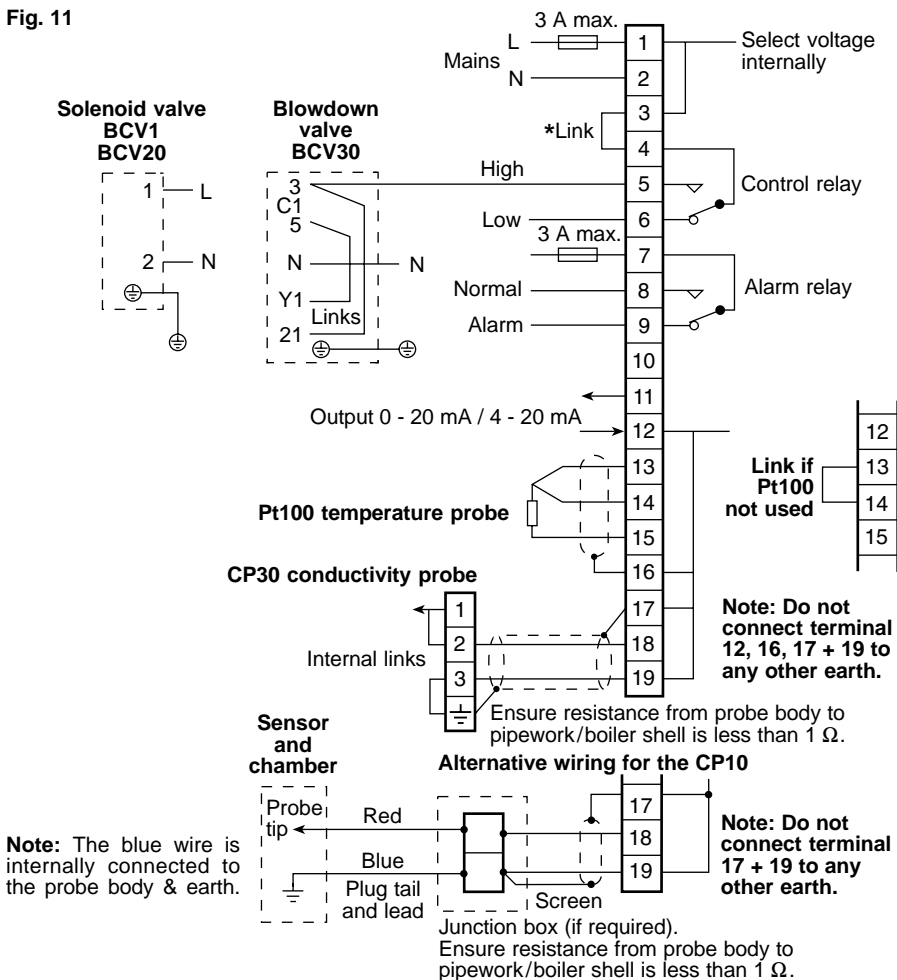

Notes on the wiring diagram

5.1 Screen connection

An earth current loop is created if a wire or screen is connected between two earth points, which are at different potential (voltage). If the instructions are followed correctly, then the probe and controller screen will only be connected to earth at one end.

Note: the probe earth terminal is a functional earth rather than a protective earth.

A protective earth provides protection from electric shock under a single fault condition. This product has double insulation and therefore does not require a protective earth.

A functional earth is used in order for the product to operate. In this application, the earth (pipework/tank/boiler shell) is used as the common of the probe. It also provides a sink/drain for any electrical interference.

Ensure that the screen is connected to the earth terminal of the probe and to the common terminal of the controller.

Ensure the common terminal of the controller is not internally earthed. (All Spirax Sarco boiler controls are internally isolated from earth).

The common terminal of the controller must only be earthed via the probe.

CAUTION:

Do not connect the common terminal to an earth local to the controller. To do so may induce an earth current loop, which may reduce the performance or damage the product.

Maximum cable length from the controller to the probe varies according to the controller. If multiple cables or alternative larger cable is used, any cable length up to 100 m is permissible as long as the maximum cable resistance does not exceed the values shown in the Table below.

For conductivity ranges below 1200 $\mu\text{S}/\text{cm}$, only the recommended cable should be used. Relays are shown in the power off position, with the alarm relay in 'alarm' and the control relay in the 'low' position.

If a motorised valve is to be used instead of a spring return blowdown valve, it may be powered by * a separate mains supply to the control relay. If so, connect the mains live input to terminal 4. Do not fit a link between terminals 3 and 4 in this case.

Caution: Mains supplies must be on the same phase.

Link terminals 13 and 14 if a temperature sensor is not used.

The 0 - 20 mA or 4 - 20 mA output represents the controller range and may be used for remote TDS display, as a chart recorder input, or as an input to a computer monitoring system.

Note: The -ve is earthed.

No link is required between terminals 11 and 12 if the transmitter output is not used.

Maximum water conductivity (at 25°C)	Maximum cable resistance	Maximum cable length (m)	
		2 core cable (Single cores)	4 core cable (2 cores in parallel)
12000 $\mu\text{S}/\text{cm}$	0.11 Ω	6.25	12.5
8000 $\mu\text{S}/\text{cm}$	0.17 Ω	9.50	19.0
4000 $\mu\text{S}/\text{cm}$	0.35 Ω	19.00	38.0
1500 $\mu\text{S}/\text{cm}$	0.90 Ω	50.00	100.0
1200 $\mu\text{S}/\text{cm}$	0.90 Ω	100.00	-

6. Commissioning

The procedure for setting the controller for boiler blowdown duties is similar to other applications. Use a small screwdriver to adjust the potentiometers.

6.1 Calibration:

- With the boiler at operating temperature, measure the TDS or conductivity of the boiler water. The Spirax Sarco MS1 conductivity meter is a suitable instrument for this purpose.
- Check that the controller is set to an appropriate range. Reset if necessary.
- Set both CAL (calibration) potentiometers to mid-point.
- Turn the SP (set point) potentiometer to indicate the TDS measured.
- Turn the left hand CAL potentiometer slowly anticlockwise until the green LED just lights.
- Turn the right hand CAL potentiometer (\pm fine adjustment) slowly clockwise until the amber LED just lights. The green LED will go out at the same time.
- The controller is now calibrated to the TDS concentration in the boiler. Turn the SP potentiometer to the required TDS level, i.e. the concentration at which the blowdown valve is to open.

6.2 Setting the alarm

Turn the AL potentiometer to the TDS at which the alarm is to operate. This must be higher than the set point selected.

7. Operation

During operation the controller will monitor the TDS and should control the concentration very closely by periodically opening the blowdown valve to reduce the TDS. This should result in consistent TDS readings, typically within $\pm 10\%$. Factors reducing the accuracy of control include large variations in boiler pressure (where temperature compensation is not fitted) and wide pH swings. Whenever the TDS is measured by taking a sample of boiler water, the result should be compared with the controller set point by turning the SP potentiometer until the LEDs change from green to amber or vice versa.

If the boiler is operating normally yet the readings differ significantly, the controller may simply be recalibrated to the new TDS reading.

If it is found that the calibration has drifted to more than twice its original setting, then the probe may need cleaning.

Probe cleaning facility

The probe cleaning circuit is operated by the spring loaded toggle switch on the front panel:

1. To operate, press and hold down the switch in the 'C' (cleaning) position for one minute. This causes the TDS monitoring function to be suspended, and the probe cleaning circuit to operate.
2. Release the switch 'C' to return to the normal position.
3. After 15 minutes, the controller output will have stabilised, and it should then be possible to recalibrate the controller near to its original level.

If not, the probe may not be sufficiently clean, so press and hold the switch in the 'C' position for one more minute. In most cases the controller can then be recalibrated.

In exceptional circumstances, where abnormal scaling has been allowed to occur in the boiler, it may still not be possible to re-calibrate the controller. In this case, it is permissible to increase the cleaning period in 5 minute steps up to a maximum of 30 minutes, checking the calibration after each step. Wait for 15 minutes after each cycle to allow the system to stabilise.

Important note:

The use of the probe cleaning function must not be regarded as a substitute for adequate water treatment. If scale is forming on the probe tip it is a certain warning that scale will also be forming on the boiler tubes. Boiler water treatment must be investigated.

Over-use of the probe cleaning function may shorten the life of the probe.

7. Maintenance

No special servicing or maintenance of the controller is necessary. The following maintenance, however is recommended for the system.

Weekly

Take a sample of the boiler water through a sample cooler, measure its TDS and check the controller calibration with the boiler at normal operating pressure. Check that the blowdown valve shuts off when the green LED is lit or when the power is removed. Operate any stop valves to ensure they shut off and remain free.

Every six months

Isolate the system (or with the boiler empty) and remove the conductivity probe. Clean the tip with fine abrasive paper and the insulation with a bristle brush or cloth. Examine the blowdown control valve/solenoid valve, stop valve and other fittings. Clean and refit or replace any parts necessary.

Available spares

Spare fuses	Stock No. 4033380	Set of 3
-------------	-------------------	----------

8. *Fault finding*

Problems experienced during commissioning are often found to be due to incorrect wiring or setting up, so we recommend that a complete check is carried out for such faults as:

- The neutral not connected.
- The live supply not linked between controller terminals 3 and 4.
- No link fitted between terminals 13 and 14 when a temperature sensor is not used.
- Always check the wiring to the conductivity probe particularly carefully, as it is easy to make a mistake with the probe terminals.
- The controller may be checked for correct operation by substituting a resistor for the conductivity probe. This will allow the various controller functions to be tested.
- Disconnect the conductivity probe.
- Disconnect the Pt100 temperature sensor if fitted, and fit a wire link between terminal 13 and 14. This should already be present if no Pt100 is fitted.
- Set switch 5 to ON, (no Pt100).
- Set switch 7 to OFF, ($\mu\text{S}/\text{cm}$).
- Select the left hand CAL potentiometer to '2' and the right hand one at mid point.
- Select a resistor from the Table below and connect it between controller terminals 18 and 19. The resistor values shown for each setting will give a midpoint reading (approximately).

Range setting	Resistor value
10 - 40 $\mu\text{S}/\text{cm}$	6.8 K
40 - 120 $\mu\text{S}/\text{cm}$	2.2 K
120 - 400 $\mu\text{S}/\text{cm}$	680 Ω
400 - 1 200 $\mu\text{S}/\text{cm}$	220 Ω
1 200 - 4 000 $\mu\text{S}/\text{cm}$	68 Ω
4 000 - 12 000 $\mu\text{S}/\text{cm}$	680 Ω