



TI-P324-02-E
 CH Issue 4.1 - 2016

Colima TOR Series Magnetic Level Switches

Description

Magnetic-activated level switches for controlling liquid levels in most industrial applications.
 Instruments with rigid rod for vertical installation.
 Used for full automation of control management, including pressurised tanks, tubs, boilers and for the control of pumps, valves and alarm systems.



Standards and certifications

Instruments compliant with the European Directive ATEX 2014/34/EU. RINA, Lloyd Register and M.M.I. and Gost R approved.



Available types



Type **TOR A** made entirely of stainless steel, with weatherproof housing and thread connection.

TOR A		<p>Type A is recommended for most industrial applications. All wetted parts are made totally of stainless steel.</p> <p>Type A is equipped with reed switches, which allows control of up to six switching points with a single instrument.</p> <p>Type A is equipped with a potentiometer transmitter allowing continuous reading of liquid level.</p>	A
TOR B		<p>Type B is recommended for liquids with low specific weight such as hydrocarbons and mineral oils. Floats are made of BUNA N, the other wetted parts are made entirely of stainless steel.</p> <p>Type B is equipped with reed switch contacts, which allows the control of up to six switching points with a single instrument.</p> <p>Type B is equipped with a potentiometer transmitter allowing the continuous reading of the liquid level.</p>	B

TOR PC		<p>Type PC is recommended for corrosive liquids, such as acids and brines, where the use of stainless steel is not recommended. All wetted parts are made entirely of PVC-Polyvinylchloride.</p> <p>Type PC is equipped with reed switch contacts, which allows the control of up to six switching points with a single instrument.</p> <p>Type PC is equipped with a potentiometer transmitter allowing the continuous reading of the liquid level.</p>	PC
---------------	--	---	-----------

<p>TOR PP</p>  <p>Type PP is recommended for corrosive liquids, such as acids and brines, where the use of stainless steel is not recommended. All wetted parts are made entirely of PP-Polypropylene. Type PP is equipped with reed switches, which allow control of up to six switching points with a single instrument. Type PP is equipped with a potentiometer transmitter allowing continuous reading of liquid level.</p>	<p>PP</p>
<p>TOR PF</p>  <p>Type PF is recommended for corrosive liquids, such as acids and brines, where the use of stainless steel is not recommended. All wetted parts are made entirely of PVDF-Polyvinylidene fluoride. The PF is equipped with reed switch contacts, which allows control of up to six switching points with a single instrument. The PF is equipped with a potentiometer transmitter allowing continuous reading of liquid level.</p>	<p>PF</p>
<p>TOR CD</p>  <p>The compact type CD is recommended for applications in hydraulic control units. It can also be used with liquids with low specific weight such as hydrocarbons and mineral oils. The floats are made of stainless steel or BUNA N, the other wetted parts are made of stainless steel. The compact type CD can be equipped with reed switch contacts, allowing control of up to two switching points with a single instrument. In place of the housing, a three-pin DIN connector with flying plug is used.</p>	<p>CD</p>

Mounting

The TOR series level switches are installed vertically on the top of the tank or externally in a chamber connected to the tank.

Manufacturing characteristics

Materials and sizing are defined in relation to the characteristics of the liquid and the project conditions.

Housings

Protection degree IP67 and IP68 on request.
For general applications in weatherproof execution.
For hazardous areas in explosion-proof execution ATEX  II 1/2 G EEx d IIC T6, T5 resp. T4 certified.
Only for TOR CD DIN IP64 connector.

Electrical equipment

SPST SPDT
DPDT (two simultaneous SPDT contacts)

Potentiometer transmitter

Reed switch chain transmitter with divisions reading every 5, 10, 20 mm. Converter for output signal 4+20 mA, Available for safe areas or ATEX EEx-i certified approved for plants. Also available with Hart® protocol, suitable for intrinsically safety, ATEX EEx-ia certified.
Can only be used with types A - B - PC - PP - PF.

Operating principle

One or more magnetic contacts (reed switches) or a reed switch 'chain' potentiometer transmitter are placed inside a sealed vertical tube, joined to the locking system.

Contacts



One or more floats, free to slide along the guide tube depending on the liquid level inside the tank, acting magnetically on contacts placed at the operation point, switching their status from normally open (NO) to normally closed (NC) position or vice versa.
Switching points are always field adjustable.

Transmitter

A float, free to slide along the guide tube depending on the liquid level inside the tank, acts magnetically on the transmitter.
The level is continuously transmitted.

Length of rod

Minimum length 100 mm
Maximum length 5000 mm

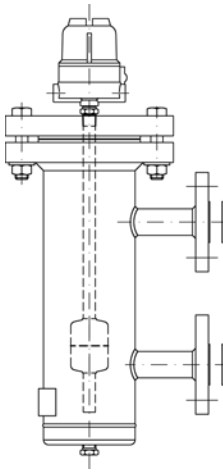
<p>TOR FL (Free Wires)</p>  <p>Model FL is designed for naval applications. Float built in stainless steel or BUNA N; other wetted parts built in stainless steel. Model FL can be fitted only with reed switch contacts, with a single tool allows to control up to three fixed switching points. The FL is not equipped with housing. A sheath of heat-shrinkable material protects the output cable. The enclosure rating is IP67.</p>	<p>FL</p>	<p>TOR M (Metric)</p>  <p>Model M is designed for applications on tanks that are not provided with level gauge and which requires manual and visual reading of the level. The level reading is achieved using a scale tape inserted into the rod: slowly pulling out the tape, it is possible to detect the liquid level through the interaction of the magnet of the float and the magnet on the bottom of the graduated tape. Floats are built in stainless steel or BUNA N, other wetted parts built in stainless steel.</p>	<p>M</p>
<p>TOR C (in Chamber)</p>  <p>Version C is provided with restraint chamber, for installations external to the tank, according to PED 2014/68/EU. The C type is designed to show local fluid level is also available a sight glass, on request. Floats are built in stainless steel or BUNA N, connections to the process and chamber camera in ASTM or AISI 316. Fittings with reed switch contacts, to control up to three switching points with a single tool. The C type is fitted with potentiometric transmitter, allows the continuous reading of the liquid level. On request, it is possible the simultaneous presence of reed-switches and transmitter, placed on two separate rods.</p>	<p>C</p>		

Wetted parts

	Flanged or threaded						Float							
Steel	A105	1	304LSS	2	316LSS	3	316LSS	A	Titanium	B	Monel	C	Hastelloy	D
Plastic	PVC	4	PP	5	PVDF	6	PVC	E	PP	F	PVDF	G	Buna N	H

Float diameters to be used with flanged connection

Steel	Ø44	44	Flanges ≥ DN50 - 2" ASME (ANSI)	Ø55	55	Flanges ≥ DN65 - 2½" ASME (ANSI)
				Ø72	72	Flanges ≥ DN80 - 3" ASME (ANSI)
Buna N	Ø44	44	Flanges ≥ DN50 - 2" ASME (ANSI)	Ø58	58	Flanges ≥ DN65 - 2½" ASME (ANSI)
Plastic	Ø70	70	Flanges ≥ DN80 - 3" ASME (ANSI)	Ø55	55	Flanges ≥ DN65 - 2½" ASME (ANSI)

Float diameters to be used with threaded connections

Steel	Ø44	44	Thread ≥ G 1½" M (NPT not applicable)	Ø55	55	Thread ≥ G 2" M (NPT not applicable)
	Ø30	30	Thread ≥ G 1" M	Ø72	72	Thread ≥ G 3" M
Buna N	Ø30	30	Thread ≥ G 1" M	Ø58	58	Thread ≥ G 2½" M
	Ø44	44	Thread ≥ G 1½" M			
Plastic	Ø70	70	Thread ≥ G 2½" M	Ø55	55	Thread ≥ G 2" M (NPT not applicable)

Note: the size of the float is subject to fluid specific gravity; the sizes shown are for standard floats. Other sizes can be made on request.

Process connections

UNI and ASME (ANSI) flanges **FL**

Threads **FI**

UNI	PN6	PN10/PN16	PN40	PN64
DN50	UA	UB	UC	UD
DN65	UE	UF	UG	UH
DN80	UI	UL UM	UN	UO
DN100	UP	UQ	UR	US
DN125	UT	UU	UV	UZ

ASME	150	300	600
2"	AA	AB	AC
2½"	AD	AE	AF
3"	AG	AJ	AH
4"	AI	AL	AM
5"	AN	AO	AP

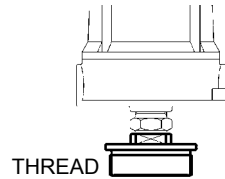

G M	
1"	F
1½"	FA
2"	FB
2½"	FC
3"	FD
4"	FE

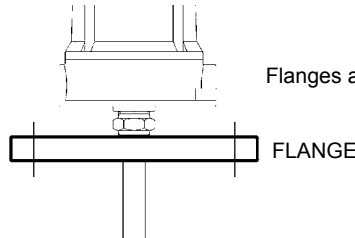

Flanges and threads are available in other sizes on request.

TOR C connections (With LL and LF chamber)

UNI and ANSI flanges (FL)

UNI	CA	DN 20	PN16
	CB	DN 20	PN40
	CC	DN 20	PN64
	CD	DN 20	PN100
	CE	DN 25	PN16
	CF	DN 25	PN40
	CG	DN 25	PN64
	CH	DN 25	PN100
	CI	DN 40	PN16
	CL	DN 40	PN40
	CM	DN 40	PN64
	CN	DN 40	PN100

ANSI	DA	¾"	150
	DB	¾"	300
	DC	¾"	600
	DD	1"	150
	DE	1"	300
	DF	1"	600
	DG	1½"	150
	DH	1½"	300
	DI	1½"	600

Screwed (FI)

GK M	GA	½"
	GB	¾"
	GC	1"
	GD	1½"
NPT-M	NA	½"
	NB	¾"
	NC	1"
	ND	1½"

Socketed Weld (SW)

BW	SA	½"
	SB	¾"
	SC	1"
	SD	1½"
NPT-M	BA	½"
	BB	¾"
	BC	1"
	BD	1½"

Design conditions

TMA - Maximum allowable temperature	Steel	-110	to +200°C	
	Buna N	-20	to +80°C	
	Plastic	PVC	-20	to +70°C
		PP	-20	to +105°C
		PVDF	-20	to +130°C
PMA - Maximum allowable pressure	Steel	< 100 bar g		
	Buna N	< 16 bar g		
	Plastic	< 16 bar g		
Fluid specific gravity	Steel and plastic	> 0.8 kg/l		
	Buna N/Titanium	> 0.5 kg/l		
Differential		fixed 8 mm		

Type **TOR A** with weatherproof housing, steel float and a reed switch contact

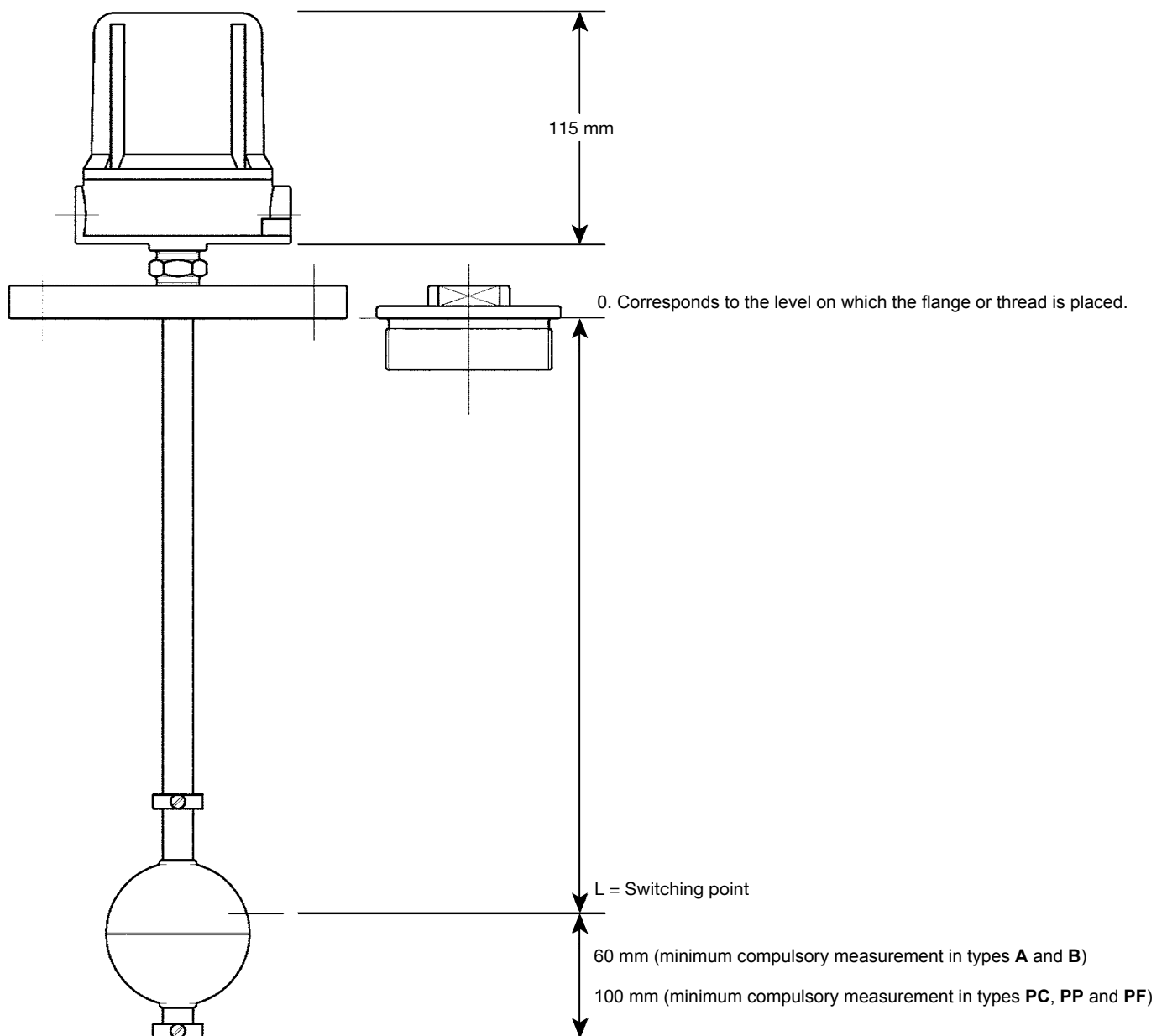

Colima electrical equipment and housings for Colima TOR series magnetic level switches

Description

The electrical equipment in TOR series magnetic level switches comprises one or more reed switch contacts, fitted inside a sealed stainless steel tube.

Wires are welded to the contacts connected to the terminal board inside the housing.

Contacts are activated by floats that slide along the tube. The floats contain a magnetic system that, when the level of liquid rises or falls, switch the state of each contact quickly and reliably.

The position of the contacts at the required switching points are set in the factory but is always field adjustable.



Reed switch contact characteristics

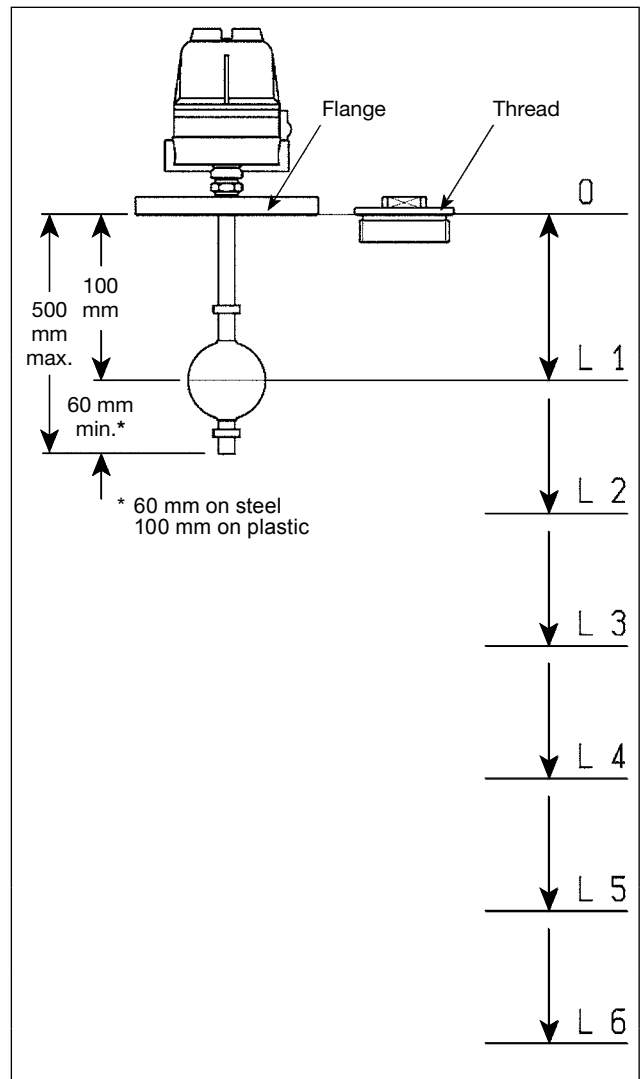
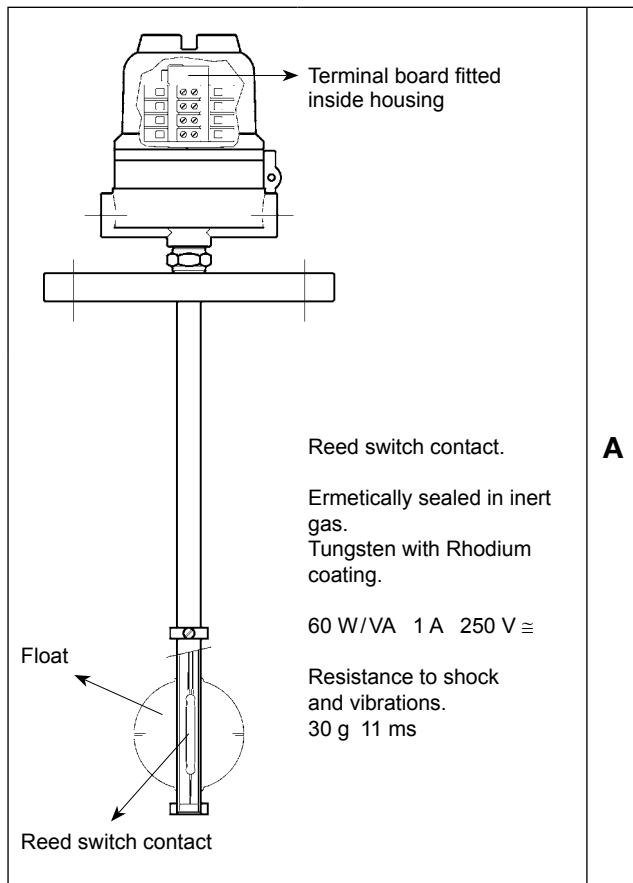

SPDT execution	1
DPDT execution (two simultaneous SPDT contacts)	2

Wiring diagram

Maximum number of contacts per instrument

The terminal board inside the housing can connect a maximum number of 18 cables.

Each contact has the following number of wires:

- 3 wires in **SPDT** contacts
- 6 wires in **DPDT** contacts

The various possible combinations of contacts must be taken into account:

(Example of how many contacts can be installed in one instrument:

- 6 SPDT or
- 2 SPDT + 2 DPDT or
- 5 SPDT or
- 4 SPDT + 1 DPDT etc.).

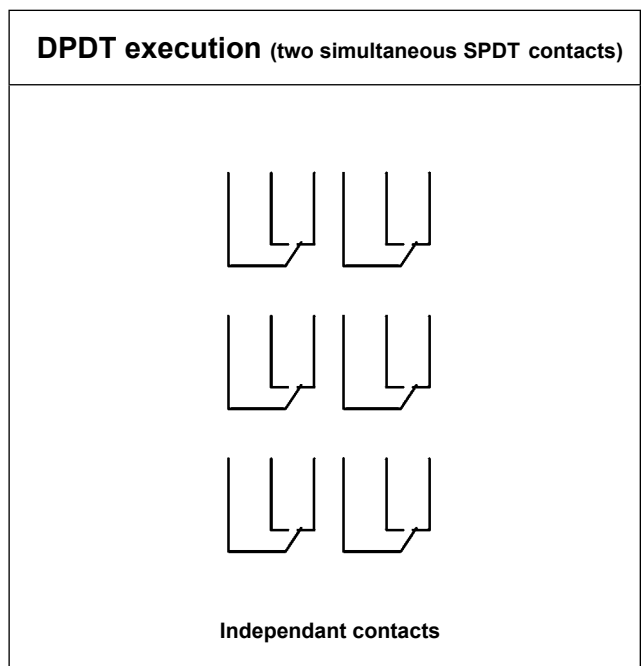
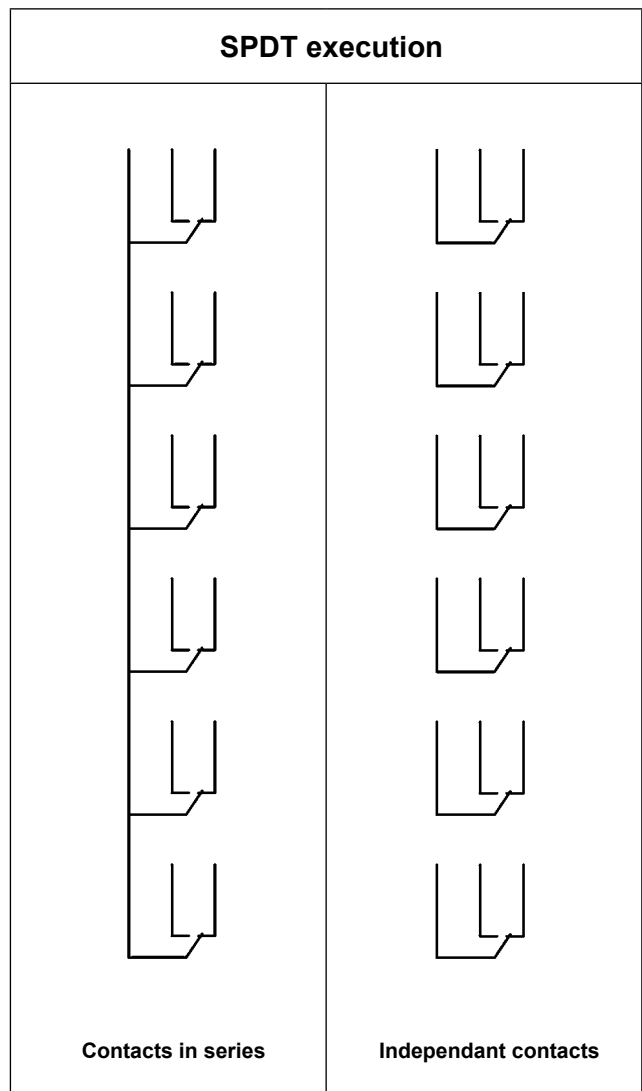

Potentiometer transmitter characteristics

A potentiometer, a device comprising a printed circuit board on which a reed / resistance chain is welded, is placed inside the float's vertical guide tube.

The total resistance of a known value is measured at the ends of this potentiometer.

The float, following the liquid level trend, activates the potentiometer's reed contact chain through its own magnetic field, locally closing the signal.

The total value of the resistance, is measured 100% at its maximum level and 0% at its minimum level.

The end poles of the potentiometer are connected to a converter that transforms the input value into Ohm and the output into mA.

Reading resolution available: 5, 10, 20 mm
Resistance input 1 k ÷ 100 k Ohm.

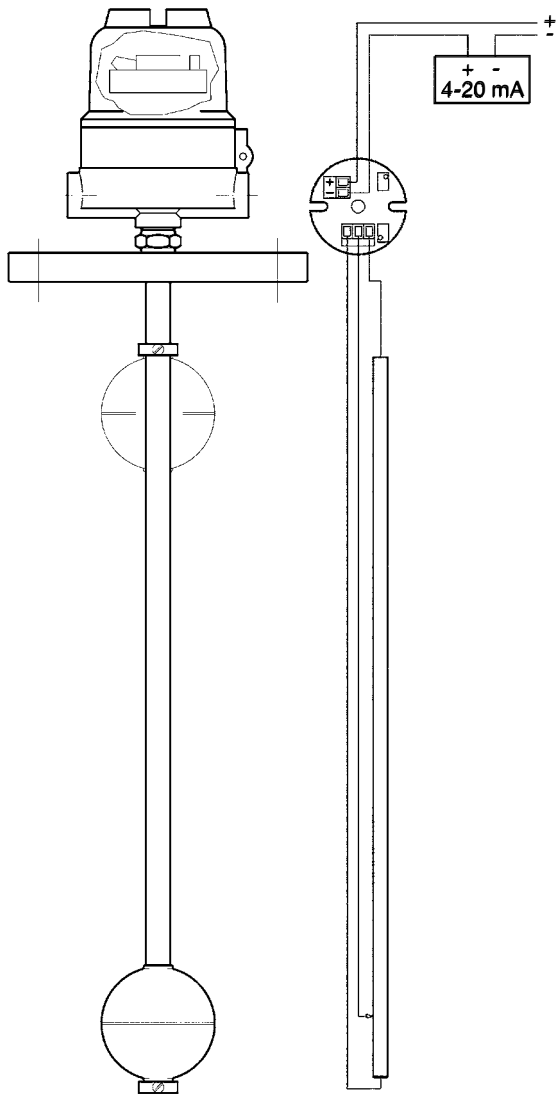

T

Converter characteristics

The Ohm-mA signal converters are inside the housing.

Three types of converter are available:

- Converter for safe zone
- Converter for inbuilt safety zone, ATEX certified.
- Converter suitable for HART® protocol, intrinsically safe, ATEX certified

Resistance input 1 k ÷ 100 k Ohm

Current output 4÷20 mA

Type 1 and 2 converters can be field set using two trimmers [for the Z (zero) gauging and G (Gain) gauging], without resorting to interconnecting systems.

The type 3 converter must be regulated with an interconnection cable.

C

Converter for safe zone

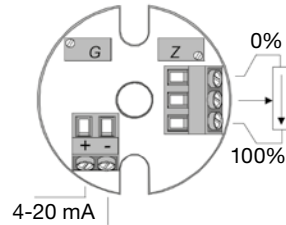

1

Converter for inbuilt safety zone

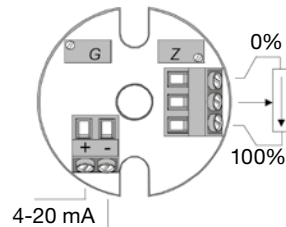

2

Converter for HART® protocol

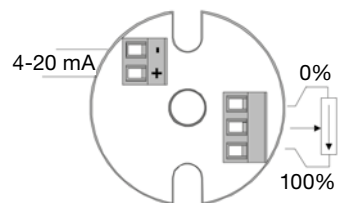



3

The TOR series magnetic level switch housings are available in various forms to meet all possible application needs and are suited to most environmental and safety conditions. They are available in the normal version for general use and the explosion-proof version for use in hazardous areas.

Electrical connections

The housings allow for two cable entry points which are available as follows:

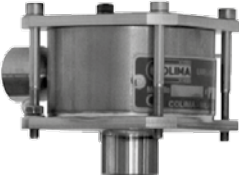
Standard	G ½" F	A
Explosion-proof	Gk ½" F	B
On request	½" NPT F	C
	M20 x 1.5	D
	PG 13.5	E

<p>Weatherproof housing</p>  <p>Type 1 is designed for use on general purpose industrial applications. Manufactured using pressure die-cast aluminium and protected with polyamide paint. Protection degree IP67. Up to two cable entrances.</p>	1
<p>Weatherproof housing</p>  <p>The type 2 has been designed for lower temperature applications, installation in high concentration saline environments and for use in the food industry. Manufactured entirely in stainless steel. Protection degree IP67. On request IP68. Up to two cable entrances.</p>	2
<p>Explosion-proof housing</p>  <p>The type 3 has an explosion-proof housing - ATEX certified $\text{II 1/2 G EEx d IIC T6, T5}$ resp. T4 for use in hazardous areas. Manufactured using pressure die-cast aluminium with a polyamide paint. Protection degree IP67. Up to two cable entrances.</p>	3

Dimensions (approximate) in mm

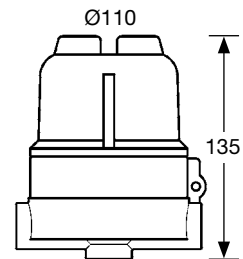
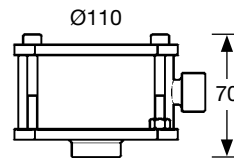
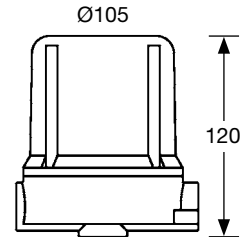

Product selection and order placement

Each unit is identified by a unique alphanumeric code that defines the manufacturing characteristics that best suits the application. Please confirm the following information before commencement of the product configuration.

Process pressure = _____ Process temperature = _____
 Design pressure = _____ Design temperature = _____
 Fluid type = _____
 Specific gravity of fluid = _____
 Viscosity of fluid = _____

Range	Colima		Colima
Model	T	TOR	T
Type	A	Wetted parts stainless steel	A
	B	Wetted parts stainless steel, float BUNA N	
	PC	Wetted parts PVC	
	PP	Wetted parts PP	
	PF	Wetted parts PVDF	
	CD	Miniature type without housing, DIN connector with plug	
Rod length	Insert length (100 to 5000 mm) CD Model (100 to 1500 mm)		
Option	T	Anti-turbulence tube	T
Housing	1	IP67 General purpose	1
	2*	IP67 Stainless steel (2 SPDT max) *economic version	
	3	ATEX certified (ATEX 2014/34/EU)	
Electrical connections	1	G ½" F	1
	2	Gk ½" F	
	3	½" NPT F	
	4	M20 x 1.5	
	5	PG 13.5	
Connections	F	Flanged connection	F
	T	Thread connection	
	X	Chamber L/L	
	Y	Chamber L/F	
Flange or thread material	1	A 105 stainless steel	2
	2	304 stainless steel	
	3	316L stainless steel	
	4	PVC	
	5	PP	
	6	PVDF	
Flange or thread rating	Refer to page 4		UA
Float material	A	316 stainless steel (-25°C to 350°C)	B
	B	Titanium (-25°C to 350°C)	
	C	Monel (-25°C to 350°C)	
	D	Hastelloy (-25°C to 350°C)	
	E	PVC (-20°C to 70°C)	
	F	PP (-20°C to 105°C)	
	G	PVDF (-20°C to 130°C)	
	H	BUNA N (-20°C to 80°C)	
Float diameter	30	Ø 30 BUNA N / Steel	72
	44	Ø 44 BUNA N / Steel	
	58	Ø 58 BUNA N	
	55	Ø 55 Steel / Plastic	
	70	Ø 70 Plastic	
	72	Ø 72 Steel	
Float number	from 1 up to 6		2
Electrical equipment switches	1	SPDT	2
	2	DPDT	
SPDT contact number	from 1 up to 6		
DPDT contact number	from 1 up to 3		
Electrical equipment transmitter	T5	5 mm	T10-C3
	T10	10 mm	
	T20	20 mm	
	C3	Converter for safe area	
	C4	Converter for in built safe area	
	C5	Converter Hart® protocol	

How to order example: 1 off Spirax Sarco Colima T-A-T-1-1-F-2-UA-B-72-2-2-T10-C3.