

LC2500

Level Controller

Installation and Maintenance Instructions

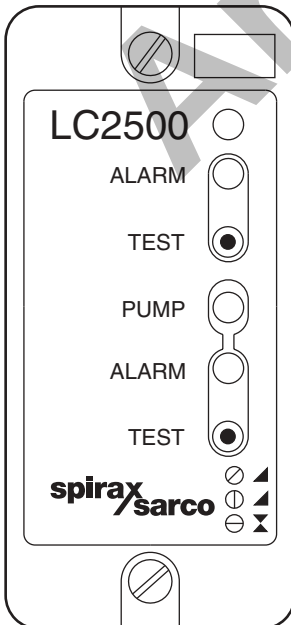

1. *General safety information*
2. *General product information*
3. *Installation*
4. *Setting up the controller*
5. *Wiring diagrams*
6. *Commissioning*
7. *Maintenance*
8. *Fault finding*

1. General safety information

Your attention is drawn to Safety Information Sheet IM-GCM-10 as well as to any National or local regulations.

Safe operation of the product depends on it being properly installed, commissioned and maintained by a qualified person in compliance with the operating instructions.

It is essential to comply with general installation and safety instructions for pipeline and plant construction, as well as to make proper use of tools and safety equipment.

The product is designed and constructed to withstand the forces encountered during normal use. Use of the product for any other purpose, or failure to install the product in accordance with these Installation and Maintenance Instructions, could cause damage to the product, will invalidate any CE marking, and may cause injury or fatality to personnel.

Additional Safety Notes:

Level control and level limiting products in steam boilers

Products/systems must be selected, installed, operated, and tested in accordance with:

- Local or National standards and regulations.
- Guidance Notes, (Health and Safety Executive PM5 in the UK).
- The requirements of Approvals Authorities.
- Boiler inspection bodies.
- Boiler manufacturer's specifications.

Two independent low water limiting systems must be installed on steam boilers. Level probes must be installed in separate protection tubes/chambers, with sufficient clearance between the tips, and earth.

Each probe must be connected to an independent controller. The alarm relays must isolate the boiler heat supply at low alarm status.

A high water alarm may be part of the water level control, or a separate system. An independent high water alarm system must be fitted if it is considered a safety requirement. In this case, the relays must simultaneously isolate the feedwater supply and the boiler heat supply at high alarm status. All boiler water limiters require regular functional testing.

A suitable water treatment regime must be used to ensure continuous safe and correct operation of the control and limiter systems. Consult the above authorities and a competent water treatment company.

Warning

Isolate the mains supply before unplugging the controller since hazardous voltages will be exposed on the controller base. This product complies with the requirements of Electromagnetic Compatibility Directive 89/336/EEC by meeting the standards of:

- Emissions EN 61326: 1997 A1 + A2 Class B equipment Table 4.
- Immunity EN 61326: 1997 A1 + A2 Class A equipment Table 1.

The following conditions should be avoided as they may create interference above the limits specified in EN 61326 (Immunity) if:

- The product or its wiring is located near a radio transmitter.
- Excessive electrical noise occurs on the mains supply. Power line protectors (ac) should be installed if mains supply noise is likely. Protectors can combine filtering, suppression, surge and spike arrestors.
- Cellular telephones and mobile radios may cause interference if used within approximately 1 metre (39") of the product or its wiring. The actual separation distance necessary will vary according to the surroundings of the installation and the power of the transmitter.

If this product is not used in the manner specified by this IMI, then the protection provided may be impaired.

— 2. General product information —

The LC2500 is a two channel level controller with adjustable switching levels, and is normally used in conjunction with a capacitance type level probe.

Either of the channels, (designated A and B), can be set to provide a high or low alarm, and channel B can also provide an adjustable pump on/off control.

Alternatively, the controller can power and accept a 4-20 mA signal from a pressure or differential pressure transmitter if required.

The LC2500 has a wave filter function which acts as a damper, preventing over-frequent relay operation in turbulent conditions.

An additional safety feature is an 'out of range' alarm. This operates if the probe or wiring is damaged, or if the probe has been wired incorrectly, and enables prompt action to be taken to rectify any potentially dangerous situation.

The controller is set on installation to suit the mains supply voltage, to provide the required level control and level alarm functions, and to give the control and alarm levels required. See Section 4.1, 'Setting up the controller'.

Configuration labels are provided for the controller front panel and enclosure chassis plate, and indicate the mode selected.

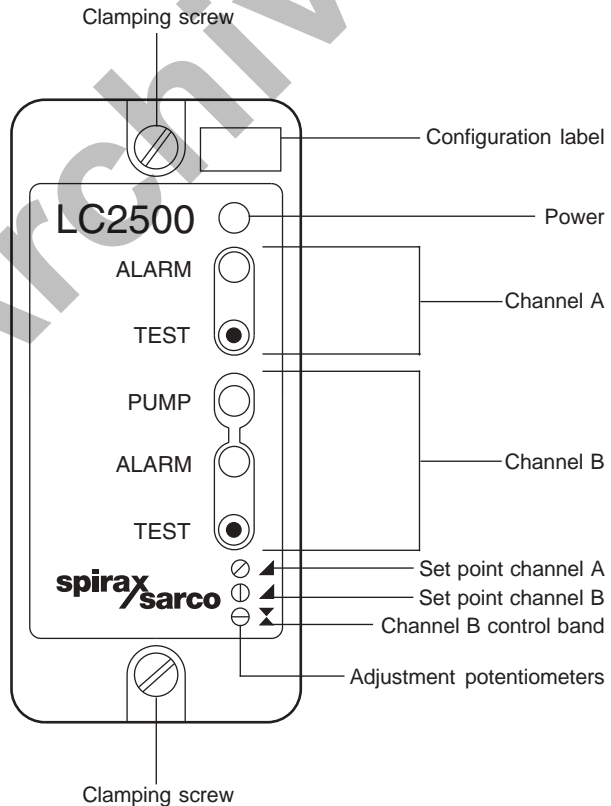

Fig. 1

Maximum ambient temperature	55°C	(131°F)
Minimum ambient temperature	0°C	(32°F)
Pollution degree	2	
Overvoltage category	II	
Indoor use only		
Altitude	2 000 m	(6 561.5 ft)
Humidity	Maximum relative humidity 80% for temperatures up to 31°C (87.8°F) decreasing linearly to 50% relative humidity at 40°C (104°F).	
Protection rating	IP40	
Mains supply voltage	230 V setting	198 V - 264 V
	115 V setting	99 V - 132 V
Frequency	50 - 60 Hz	
Fuse type	20 mm cartridge, 100 mA anti-surge (T). For the UL version, replacement fuses must be UL recognised to maintain the integrity of the approval.	
Maximum power consumption	6 VA	
Maximum cable length (controller to probe)	100 m	(328 ft)
Terminal torque rating	1 N m	(9 lbf in)

3. Installation

WARNING:

Isolate the mains supply before unplugging the controller since hazardous voltages will be exposed on the controller base.

To unplug the controller from its base, undo the two retaining screws and pull the controller straight forwards. Rocking the controller in the vertical plane will ease removal.

The controller must be installed in a suitable industrial control panel or fireproof enclosure to provide impact and environmental protection (pollution degree 2). Spirax Sarco can provide suitable plastic or metal enclosures (for standard controller only).

The controller may be mounted on a 'top hat' DIN rail using the clip provided or the clip can be removed and the controller base screwed directly to a chassis plate.

Caution: Allow 15 mm (5/8") spacing between multiple units for air circulation.

The controller is for installation category II (Overvoltage category) and must be installed in accordance with IEC 60364 or equivalent. The controller and all connected circuits must have a common isolation system which meets the relevant requirements of IEC 60947-1 and IEC 60947-3 or equivalent. This must be positioned close to the controller and clearly identified as the disconnect device.

A quick blow 3 amp external fuse must be fitted in all phases of the controller and relay supply. The relays are rated at 250 Vac and must be on the same phase as the controller supply. Cabling should be installed in accordance with BS 6739 - Instrumentation in Process Control Systems: Installation design and practice or local equivalent.

Note:- The wiring diagrams (Section 5) show all relays in the power off position.

Screened high temperature, 3 core, 1 mm² (18 - 16 AWG) copper cable is required for the probe wiring. The maximum permitted length is 100 metres (328 ft). Use cable with a suitable temperature rating for the installation. Pirelli FP200 or Delta Crompton Firetuf OHLS are suitable cables for the standard version. Use NEC Class 1 wiring for UL version. Connect the screens as shown in the wiring diagrams (Section 5).

If the product is not used in the manner specified in this IMI, then the protection provided may be impaired.

Relay rating table:

Version	Relay load type	Rating
Standard	Resistive at 250 Vac	3 A
	Inductive at 250 Vac	1 A
	Lamp or resistive at 240 Vac	3 A
	Tungsten filament at 240 Vac	1 A
UL Listed	ac motor at 240 Vac	¼ HP (2.9 A)
	ac motor at 120 Vac	¼ HP (3 A)
	Pilot duty (control circuits/coils)	C300 (2.5 A)

For the US and Canadian markets the controller must be wired in accordance with the National and Local Electrical Code (NEC) or Canadian Electrical Code (CEC).

4. Setting up the controller

4.1 Setting up the controller

The controller is supplied set up as follows:

- 230 V mains supply.
- Capacitance probe (Voltage) input.
- Pumping in control (Channel B).
- High water level alarm (Channel A).
- Wave filter off (Standard response).
- Out of range alarm off.

4.2 To change the mains supply voltage:

- Unplug the controller from its base.
- Remove the rear cover panel.
- Slide out the printed circuit board.
- Slide the voltage selector switch to the required setting.
- Replace the printed circuit board.
- Ensure that the LEDs and test buttons engage with the holes in the front panel.
- Replace the rear cover panel.

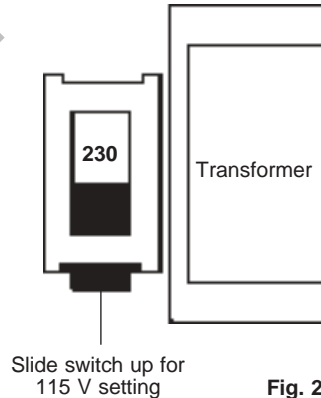

Fig. 2

4.3 To change the control and alarm functions:

- Unplug the controller from its base.
- Remove the rear cover panel.
- Slide out the printed circuit board. An 8-way switch on the printed circuit board determines the controller functions.
- Set the switches to the positions for their chosen duties as shown in Section 5, 'Wiring diagrams'.
- Replace the printed board.
- Ensure that the LEDs and test switches engage with the holes in the front panel.
- Replace the rear cover panel.

4.4 Wave filter - Switch 5

The wave filter provides a delayed response for high output boilers where waves and high turbulence may otherwise cause over-frequent switching of the controller output relays. If the wave filter is required, set Switch 5 to ON.

4.5 Out of range alarm - Switch 6

This feature causes both relays to switch off if the input voltage to the controller falls outside normal operating limits, e.g. if cable damage causes an input of less than 0.6 V (2 mA), or over 8.5 V (28 mA). Values are approximate. If this facility is required set Switch 6 to ON.

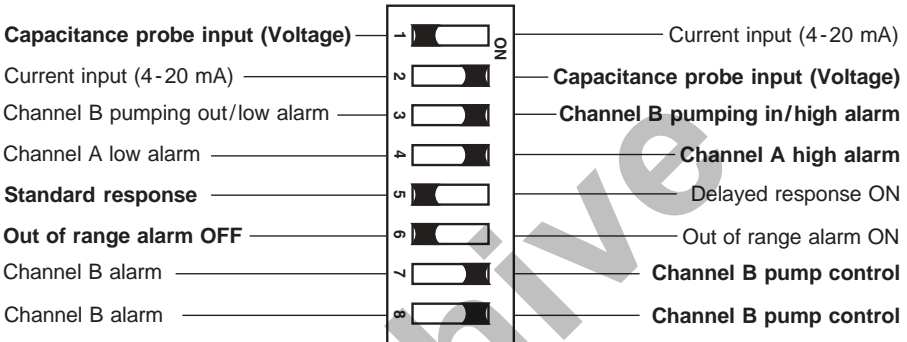

Fig. 3 The LC2500 is supplied with the switch setting set as shown in bold

5. Wiring diagrams

5.1 Screen connection

An earth current loop is created if a wire or screen is connected between two earth points, which are at different potential (voltage). If the instructions are followed correctly, then the preamplifier and controller screen will only be connected to earth at one end.

Note: The PA20 earth terminal is a functional earth rather than a protective earth.

A protective earth provides protection from electric shock under a single fault condition. This product has double insulation and therefore does not require a protective earth.

A functional earth is used in order for the product to operate. In this application, the earth (tank/boiler shell) is used as the common of the probe/preamplifier. It also provides a sink/drain for any electrical interference.

Ensure that the screen is connected to the earth terminal of the PA20 and to the common terminal of the controller.

Ensure the common terminal of the controller is not internally earthed. (All Spirax Sarco boiler controls are internally isolated from earth).

The common terminal of the controller must only be earthed via the PA20.

CAUTION:

Do not connect the common terminal to an earth local to the controller. To do so may induce an earth current loop, which may reduce the performance or damage the product.

5.2 Wiring diagram notes

The wiring diagrams show water level control using a pump.

Alternatively a normally closed solenoid valve could be used, wired to controller terminal 7, or a motorised valve wired for terminal 7 to open and terminal 8 to close the valve.

All relays are shown in the power off position. The terminals are suitable for two 1.5 mm² or 16 AWG cables (max). The torque rating of each terminal is 1 N m (9 lbf in).

5.3 Pumping in or out and low alarm Pumping in or out and high alarm

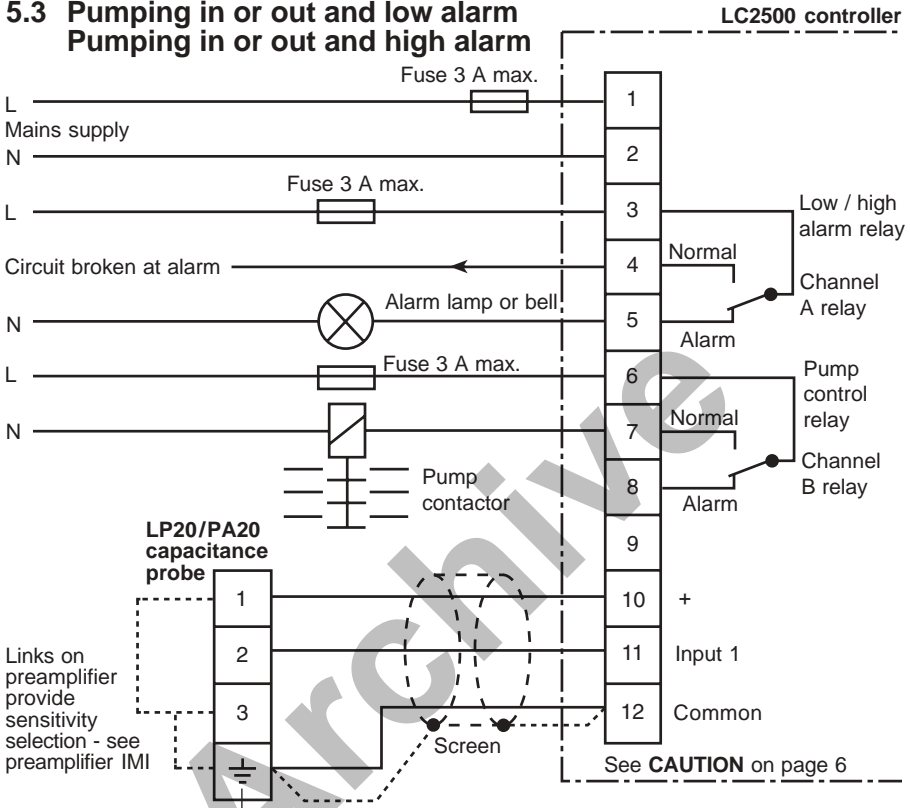

The earth terminal is internally connected to the PA20 body and earthed by the LP20 probe. **Do not** connect this earth terminal to any other earths. Ensure resistance from probe body to pipework/boiler shell is less than 1 Ω.

Fig. 4

Note: For 4-20 mA input see Section 5.6

Switch settings

Note: Switches 5 and 6 shown unset. See Sections 4.4 and 4.5

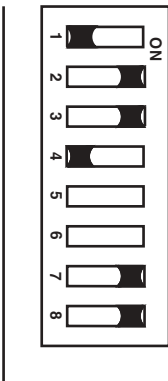

Fig. 5 Pumping in/low alarm

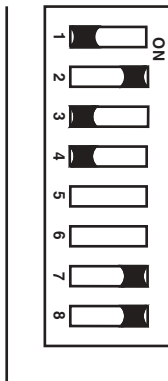

Fig. 6 Pumping out/low alarm

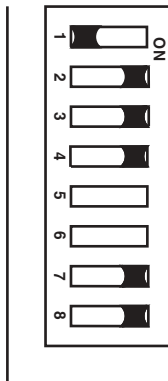

Fig. 7 Pumping in/high alarm

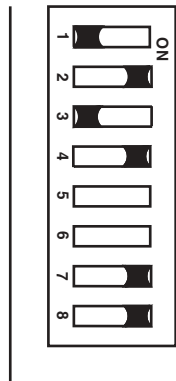
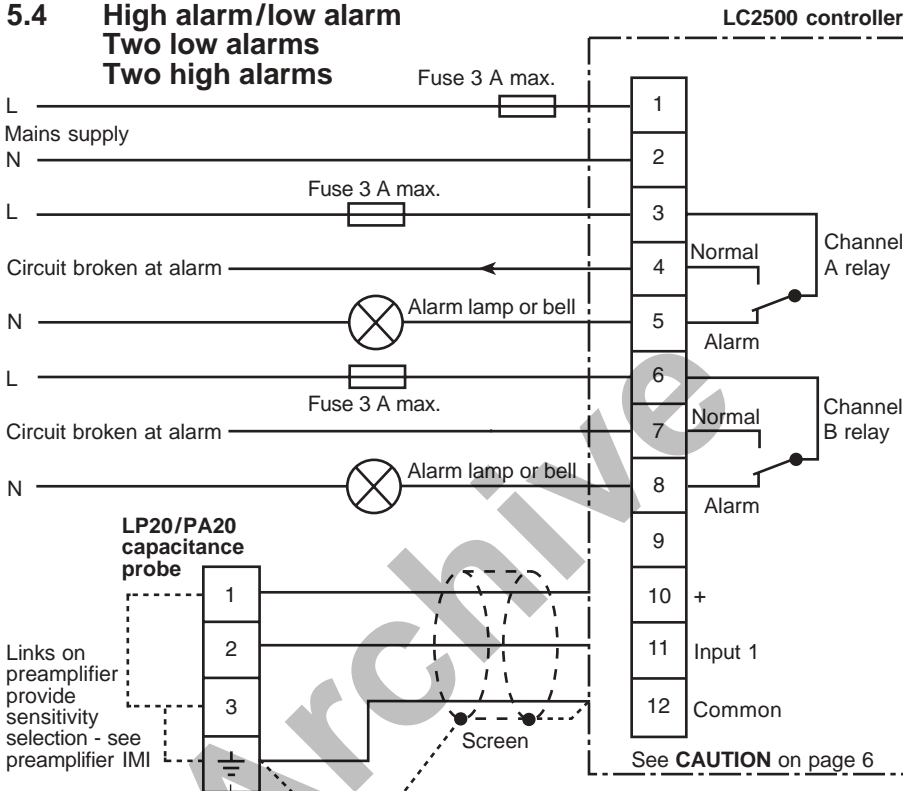

Fig. 8 Pumping out/high alarm

5.4 High alarm/low alarm Two low alarms Two high alarms



The earth terminal is internally connected to the PA20 body and earthed by the LP20 probe. **Do not** connect this earth terminal to any other earths. Ensure resistance from probe body to pipework/boiler shell is less than 1 Ω .

Fig. 9

Note: For 4-20 mA input see Section 5.6

Switch settings

Note: Switches 5 and 6 shown unset. See Sections 4.4 and 4.5

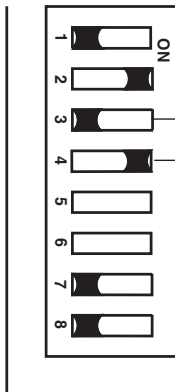

Fig. 10

High alarm/low alarm

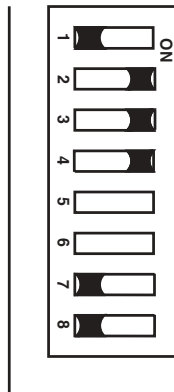

Fig. 11

Two high alarms

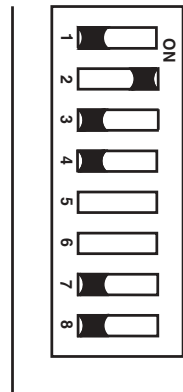

Fig. 12

Two low alarms

5.5 Wiring diagram UL version

PA20 preamplifier and LP20 capacitance probe

(see PA20 and LP20 Installation and Maintenance Instructions)

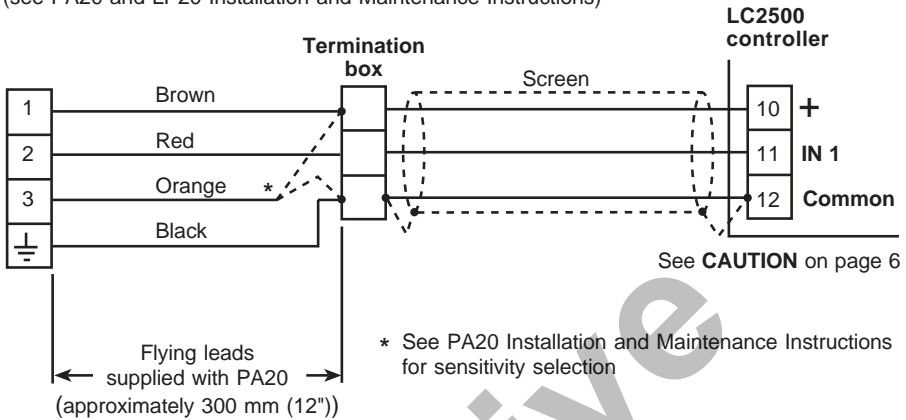

Fig. 13

5.6 Connecting to a loop or externally powered 4-20 mA transmitter

Connect wiring and set switches 1 and 2 as shown in Figures 14 and 15.

Note:- If more than one controller is connected to a 4-20 mA source, then only one unit should have switch 1 set to ON, as shown.

Where a pressure transmitter is used for level control a rising level causes a rising pressure and a rising output signal.

Where however, a differential transmitter is used for level control, it may be set up so that a rising level gives a reducing output signal.

In this case it will be necessary to reverse the alarms and pump control, e.g. set as high alarm for low alarm and set as pumping out for pumping in. Commissioning is described in Section 6.

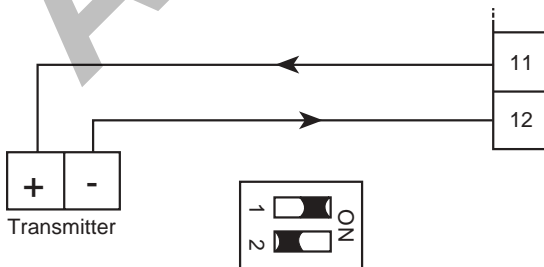

Fig. 14 4-20 mA loop powered transmitter

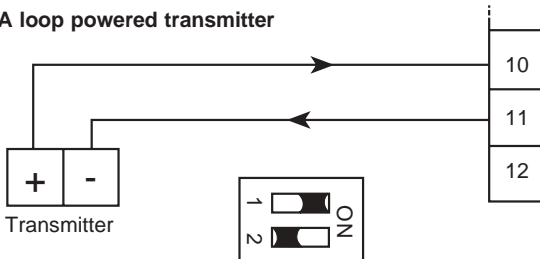

Fig. 15 4-20 mA loop externally powered transmitter

5.7 Multiple controllers

Several controllers can be connected to a single probe or 4-20 mA source if required, for example to provide multiple alarm signals.

Connect wiring and set switches 1 and 2 as shown in Fig.16.

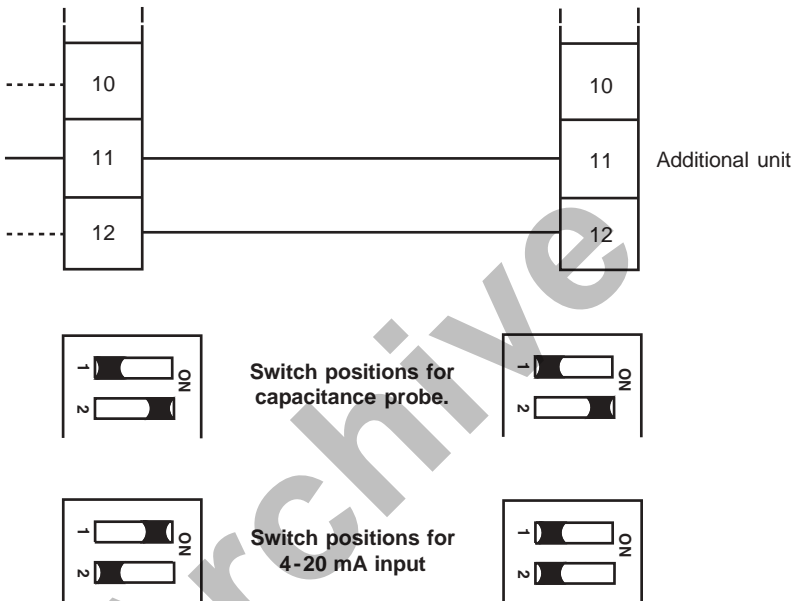

Fig. 16 Input from capacitance probe or 4-20 mA transmitter

6. Commissioning

Note: Control and alarm levels are set by adjusting the potentiometers on the front panel. Channel A is used for an alarm only. Channel B may be used either as an additional alarm, or for pump on-off control. It is not possible to set Channel B as an alarm if pump control is also required.

6.1 Commissioning the controller

Ensure the controller is set up for the correct functions and mains supply voltage. Select one of the following channel configurations:-

6.2 Two alarms (Channel A and Channel B)

Channel A

1. Alter the water level to the required alarm level.
2. Adjust the top potentiometer until the top alarm LED just lights.

Channel B

1. Turn the lower potentiometer approximately 25 turns anticlockwise.
2. Alter the water level to the other alarm level required.
3. Adjust the middle potentiometer until the lower alarm LED just lights.

Note: Turning clockwise increases the level at which the alarm operates.

6.3 One alarm (Channel A), and pump on/off control (Channel B)

Channel A

1. Alter the water level to the required alarm level.
2. Adjust the top potentiometer until the top alarm LED just lights.

Channel B - Pumping in

1. Turn the lower potentiometer approximately 25 turns anticlockwise.
2. Alter the water level to the required Set Point.
3. Adjust the middle potentiometer slowly until the green pump LED just lights.
4. Turn the lower potentiometer approximately 25 turns clockwise.
5. Raise the water level to the required 'pump off' position.
6. Adjust the lower potentiometer **very slowly** anticlockwise until the green pump LED just goes out. (This will also automatically set the 'pump on' position to an equal distance below the Set Point).

Note: If you over-adjust the potentiometer, it will be necessary to repeat the Channel B commissioning, as the LED will not light again if the potentiometer is turned clockwise.

Channel B – Pumping out

1. Turn the lower potentiometer approximately 25 turns anticlockwise.
2. Alter the water level to the required Set Point.
3. Adjust the middle potentiometer slowly until the green pump LED just lights.
4. Turn the lower potentiometer approximately 25 turns clockwise.
5. Lower the water level to the required 'pump off' position.
6. Adjust the lower potentiometer **very slowly** anticlockwise until the green pump LED just goes out.

Note: If you over-adjust the potentiometer, it will be necessary to repeat the Channel B commissioning, as the LED will not light again if the potentiometer is turned clockwise.

Explanatory note: The lower potentiometer controls hysteresis, (control band width). Rotating it 25 turns anticlockwise minimises hysteresis (1), and therefore enables the Set Point to be adjusted easily (2 and 3).

Rotating the potentiometer fully clockwise maximises the hysteresis (4) preventing the controller switching off the pump before the boiler water can be brought up to the required 'pump off' level. Finally, the hysteresis is adjusted back down to match the 'pump off' level in the boiler (6).

6.4 Checking the settings

1. Slowly alter the water level to check that the alarm and pump control levels are as required. Allow up to two minutes for the controller to respond if the wave filter is on (delayed response).
2. At normal water level press the top test button (Channel A alarm). The alarm LED should light and the alarm should sound. On releasing the test button the alarm should stop and the LED extinguish.
3. If channel B is set for alarm mode, press the bottom test button - the results should be the same.

Note:- If channel B has been set to pumping mode, pressing the test button will have no effect apart from to stop the pump if it is working at the time. The alarm LED will not light.

6.5 Caution

The water level inside a boiler can be different to that shown in the gauge glass under certain circumstances, so the settings may need minor adjustment when the boiler is running.

Literature is obtainable from Spirax Sarco which gives general information on boiler water level variations.

If the out of range alarm is set to ON (Switch 6), the low limit alarm may be tested by disconnecting the probe plug. Both relays should de-energise.

7. Maintenance

No special servicing or maintenance of the controller is necessary. Boiler water level controls and level alarms, however, do require regular testing and inspection. General safety guidance for the UK is given in Health and Executive Guidance Note PM5. For specific instructions for the Spirax Sarco system please see separate literature.

Available spares

Spare fuses	Stock No. 4033380	Set of 3
-------------	-------------------	----------

8. Fault finding

Most faults which occur on commissioning are due to incorrect wiring or setting up. In the case of problems, the following checklist may be helpful:-

Mains on LED not lit:

- No live supply.
- Neutral not connected.
- Controller internal fuse blown.

Controller internal fuse blown:

- Check the mains supply voltage is lower than 264 V, and that the ambient temperature inside the control panel is less than 55°C (131°F). If either of these limits has been exceeded, it is possible that the controller internal thermal fuse has blown, and that the controller will need to be replaced.
- Ensure that the probe supply voltage is between 24 Vdc and 35 Vdc between terminals 10 and 12 of the controller, or terminals 1 and earth of the probe.
- The probe output voltage should be 1 Vdc to 6 Vdc between terminals 11 and 12 of the controller, or terminals 2 and earth of the probe, depending on the level.
This voltage increases with the level, even when reverse acting output has been selected.