

SX25 Series Process Controller
Installation and Maintenance Instructions

- 1. Safety Information*
- 2. Installation*
- 3. Electrical connections*
- 4. Configuration*
- 5. Operations*
- 6. Commissioning examples*
- 7. Automatic tuning*
- 8. Technical specifications*

General Index

1. Safety Information

- 1.1 General
 - 1.2 Wiring Notes
 - 1.3 Safety requirements and electromagnetic compatibility
-

2. Installation

- 2.1 General description
 - 2.2 Dimensional details
 - 2.3 Panel cut-out
 - 2.4 Environmental ratings
 - 2.5 Panel mounting
-

3. Electrical connections

- 3.1 Termination
 - 3.2 Precautions and advised conductor course
 - 3.3 Wiring details
 - 3.4 Wiring examples
 - 3.5 Auxiliary relays for Valve Motor Drive actuators
-

4. Configuration

- 4.1 Configuration coding
-

5. Operations

- 5.1 Keys and display overview
 - 5.2 Display
 - 5.3 Parameter setting
 - 5.4 Parameter menu
 - 5.5 Parameter description
 - 5.6 Configuration menu
-

6. Commissioning examples

- 6.1 Example of pressure control for SX25-mA
 - 6.2 Example of temperature control for SX25-VMD
-

7. Automatic tuning

8. Technical specification

1. Safety Information

1.1 General

Please carefully read through the following before proceeding with the installation of the controller.

Your attention is drawn to Safety Information leaflet IM-GCM-10.

If the controller is handled improperly or not used as specified, the resultant may:

- cause danger of the life and limb of the third party,
- damage the controller and other assets belonging to the owner,
- hinder the performance of the controller and control system.

1.2 Wiring notes

Every effort has been made during the design of the controller to ensure the safety of the user, but the following precautions must be followed:-

- i) Maintenance personnel must be suitably qualified in working with equipment containing hazardous live voltages.
- ii) Ensure correct installation. Safety may be compromised if the installation of the product is not carried out as specified in this manual.
- iii) Isolate the controller from the mains supply before opening the unit.
- iv) The controller is designed as an installation category II product, and is reliant on the building installation for over-current protection and primary isolation.
- v) Wiring should be carried out in accordance with IEC 60364 or equivalent. For installations in the US and Canada, the controller must be wired in accordance with the Local and National Electrical Code (NEC) or the Canadian Electrical Code (CEC).
- vi) Fuses should be fitted in all phases. The instrument is protected with an internal fuse PTC, thermal protective device. To protect the instruments internal circuits use 2A T fuses for Relay outputs and 1A T fuses for Triac outputs. The Relay contacts are already protected with varistors. Fuses should not be fitted in the protective earth conductor. The disconnection or removal of other equipment must not compromise the integrity of the installation protective earth system.
- vii) The mains cable connection at the rear of the controller must be retained in position (by tie wrapping Etc.) This will prevent the high voltage cables at the rear of the controller from touching the SELV (Safe Extra Low Voltage) connections, in the unlikely event of the terminals coming loose.

viii) A disconnecting device (switch or circuit breaker) must be included in the building installation. This must be in close proximity to the equipment and within easy reach of the operator.

- There must be a 3 mm contact separation in all poles.
 - It must be marked as the disconnecting device for the controller.
 - It must not interrupt the protective earth conductor.
 - It must not be incorporated into a mains supply cord.
 - The requirements for the disconnecting device are specified in IEC 60947-1 and IEC 60947-3 or equivalent.
- ix) The controller must not be located in such a way that the disconnecting device is made difficult to operate.

1.3 Safety requirements and electromagnetic compatibility

This product is CE marked. It complies with the requirements of 73/23/EEC as amended by 93/68/EEC on the harmonisation of the law of Member States relating to electrical equipment designed for use within certain voltage limits, by meeting the standard EN 61010-1 (IEC 601010-1):90 +A1:92 + A2:95

This product complies with the requirement of 89 / 336/ EEC as amended by 92/ 31/ EEC on the approximation of laws of the Member States relating to Electromagnetic Compatibility, by meeting the standards of :

- EN 50081-2 (Industrial Emissions)
- EN 61000-6-2 (Industrial immunity)



The product may be exposed to interference above the limits of EN 61000-6-2 if:

- The product or its wiring is located near to a radio transmitter.
- Excessive electrical noise occurs on the mains supply.
- Cellular telephones and mobile radios may cause interference if used within approximately one metre of the product or its wiring. The actual separation necessary will vary according to the power of the transmitter.
- Power line protectors (ac) should be installed if mains supply noise is likely.
- Protectors can combine filtering, suppression, surge and spike arrestors.

2. Installation

2.1 General description

Installation must only be carried out by qualified personnel.

Before proceeding with the installation of this controller, follow the instructions illustrated in this manual and, particularly the installation precautions marked with the   symbol, related to the European Community directive on electrical safety and electromagnetic compatibility.



To prevent hands or metal touching parts that may be electrically live, **the controllers must be installed in an enclosure and/or in a cubicle.**

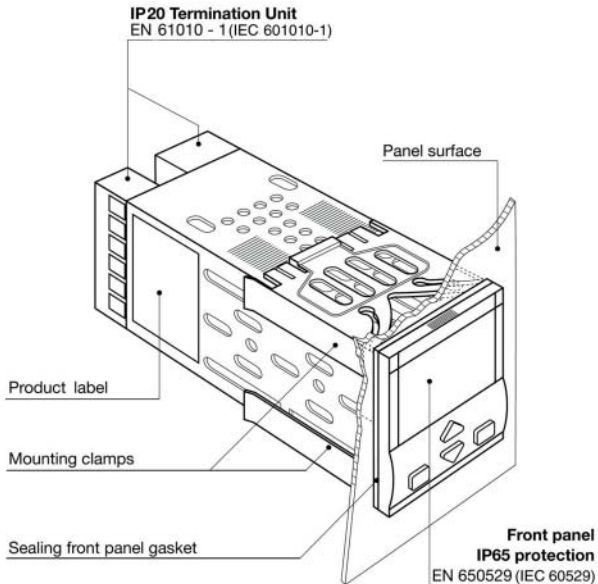

2.2 Dimensional details

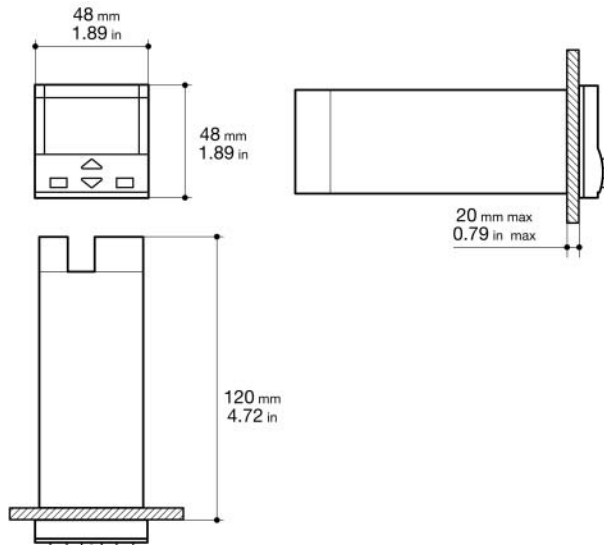

2.3 Panel cut-out

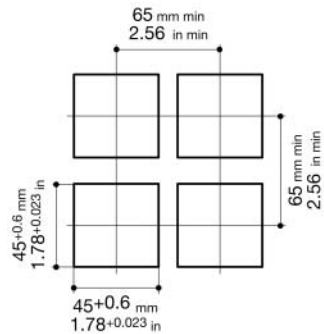

2.4 Environmental ratings

Operating conditions



Altitude up to 2 000 m (6 561 ft)



Temperature 0...50°C (32...122°F)

%Rh

Relative humidity 5...95% non-condensing

Special conditions

Suggestions



Temperature >50°C

Use forced air ventilation

%Rh

Humidity > 95%

Warm up



Conducting atmosphere

Use filter

Forbidden conditions



Corrosive atmosphere



Explosive atmosphere

2.5 Panel mounting

2.5.1 Insert the instrument

- 1 Prepare panel cut-out
- 2 Check front panel gasket position
- 3 Insert the instrument through the cut-out

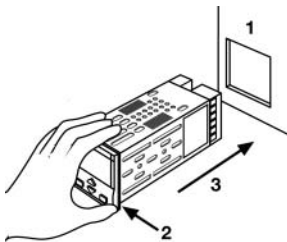

UL note:

For use on a flat surface of a Type 2 and Type 3 'raintight' enclosure.

2.5.2 Installation securing

- 1 Fit the mounting clamps
- 2 Push the mounting clamps towards the panel surface to secure the instrument

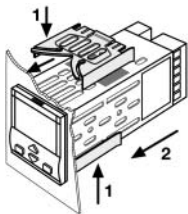

2.5.3 Clamps removing

- 1 Insert the screwdriver in the clips of the clamps
- 2 Rotate the screwdriver

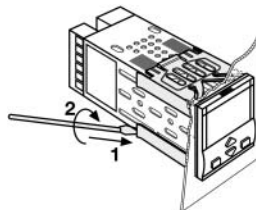

2.5.4 Instrument unplugging

- 1 Push and
- 2 pull to remove the instrument

Electrostatic discharges can damage the instrument



Before removing the instrument the operator must discharge himself to ground

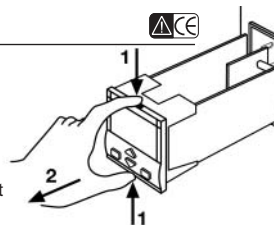

3. Electrical connections



3.1 Termination Unit

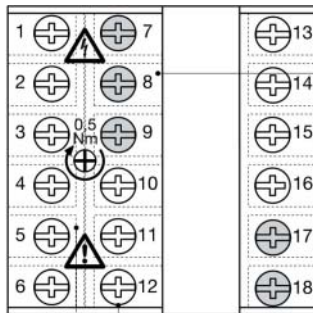
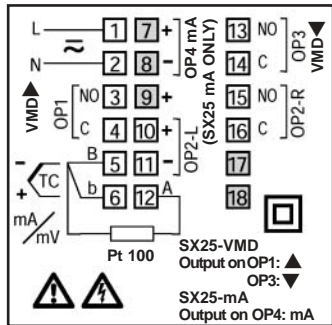

Rear terminal cover

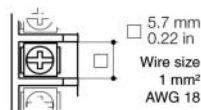

18 screw terminals



Option terminals



Holding screw
0.5 N m



Positive screw driver PH1



Negative screw driver 0.8 x 4 mm

Terminals

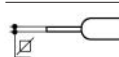

Pin connector
q 1.4 mm
0.055 in max



Fork-shape
AMP 165004
Ø 5.5 mm - 0.21 in



Stripped wire
L 5.5 mm - 0.21 in

UL note:

Use 60/70°C (140/158°F)
copper (cu) conductor only.

3.2 Precautions and advised conductor course

Despite the fact that the instrument has been designed to work in an harsh and noisy environmental (level IV of the industrial standard IEC 60801-4), it is recommended to use the following suggestions.



All the wiring must comply with the local regulations.

The supply wiring should be routed away from the power cables.

Avoid to use electromagnetic contactors, power Relays and high power motors nearby.

Avoid power units nearby, especially if controlled in phase angle

Keep the low level sensor input wires away from the power lines and the output cables.

If this is not achievable, use shielded cables on the sensor input, with the shield connected to earth.

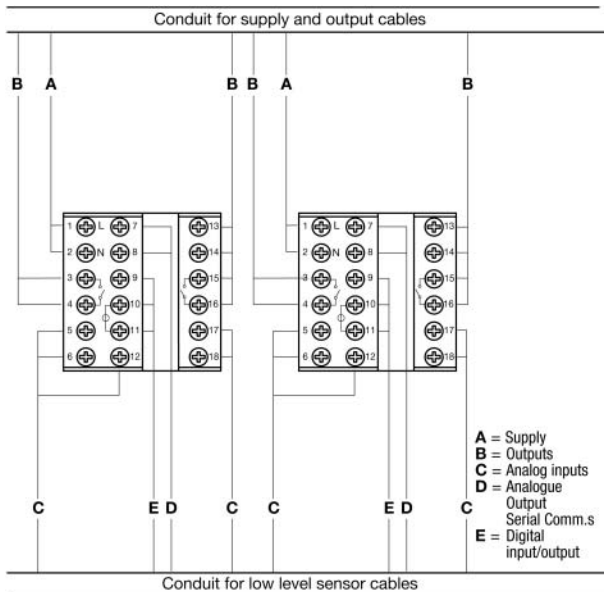

3.3 Wiring details

3.3.1 Power supply

Please read the safety information and the wiring notes before proceeding with the installation of the controller.

The controller provides switching power supply with multiple isolation and internal PTC

- Nominal voltage 100 - 240V~ (-15% +10%) Frequency 50/60Hz
- Power consumption 1.6 W max

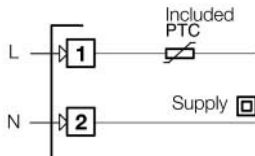

3.3.2 PV control unit

A For L-J-K-S-T thermocouple type

- Connect the wires with the polarity as shown
- Always use compensation cable of the correct type for the thermocouple used
- The shield, if present, must be connected to a proper earth

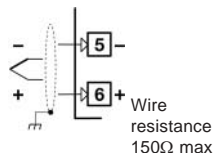

B For Pt100 temperature sensor

- If a 3 wire system is used, always use cables of the same diameter (1 mm² min.) (line 20 Ω/lead maximum resistance)
- when using a 2 wire system, always use cables of the same diameter 1mm² (AWG 18) and link terminals 5 and 6

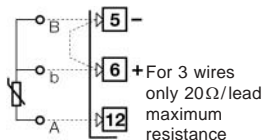

C For ΔT (2xRTD Pt100) Special

- ⚠ When the distance between the controller and the sensor and the sensor is 15 m, using a cable of 1mm² (AWG 18) diameter, produces an error on the measure of 1°C

R1 + R2 must be <320Ω

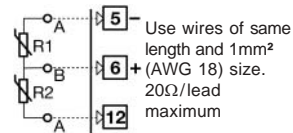

3.3.2 PV control unit

D For mA, mV

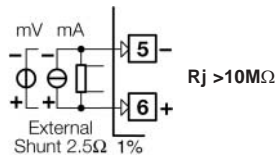

D1 With 2 wire transducer (SX25 mA only)

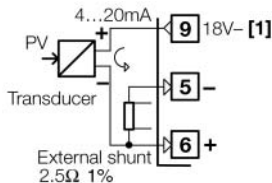

D2 With 3 wire transducer (SX25 mA only)

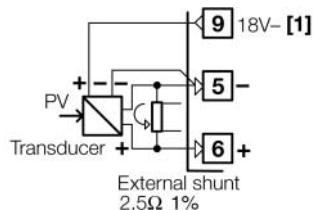

Note:

The auxiliary power supply is not available on the VMD controller.

[1] Auxiliary power supply for external transmitter 18 V \pm 20%/30 mA max. without short circuit protection



3.3.5 Output configuration

The functionality associated to each of the outputs is defined during the configuration of the instrument, index **L** (see section 4.1).

The suggested combinations are:

		Output				Alarms		
		Primary		Secondary		AL2	AL3	
SX25 mA	A	Single Action	Heat or Cool	OP4	none	none	OP2	OP3
	B	Single Action	Heat or Cool	OP4	none	none	OP1	OP3
	C	Double Action	Heat	OP4	Cool	OP3	OP2	-
	D	Double Action	Heat	OP4	Cool	OP2	-	OP3
	E	Double Action	Heat	OP1	Cool	OP4	OP2	OP3
	F	Double Action	Heat	OP2	Cool	OP4	OP1	OP3
SX25 VMD	G	Valve Motor Drive	Open	OP1	Close	OP3	OP2	OP2
	H	Single Action	Heat or Cool	OP1	none	none	OP2	OP3
	I	Single Action	Heat or Cool	OP2	none	none	OP1	OP3
	J	Double Action	Heat	OP1	Cool	OP3	OP2	-
	K	Double Action	Heat	OP1	Cool	OP2	-	OP3
	L	Double Action	Heat	OP2	Cool	OP3	OP1	-

OP1 - OP3	Relay output
OP2 - L	Logic output
OP2 - R	Relay output

Note: With heat or cool control AL2 and AL3 share the same output.

OP2 output can be Relay or logic.

The 'jumper' on the auxiliary board selects the output type:

Link Pins 1-2 for OP2-Relay
(Factory set)

Link Pins 2-3 for OP2-Logic

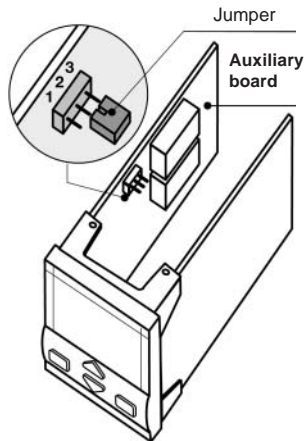

SX25 mA Output combination



3.3.5 – A, B

OP4 Analogue mA control output

- Galvanic isolation 500V~/1 min
- 0/4...20mA, (750Ω or 15V- max)

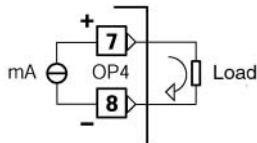

Relay output

- SPST Relay N.O., 2A/250 V~ for resistive load, fuse 2A ~ T

Logic output not isolated

- 0...5V-, ±20%, 30 mA max

OP2, use Relay (terminals 15,16) or Logic (terminals 10,11)

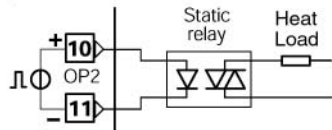

3.3.5 – C Double action analogue mA/relay control output

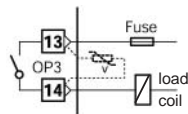
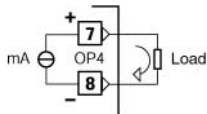

3.3.5 – D Double action analogue mA/relay control output

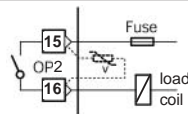
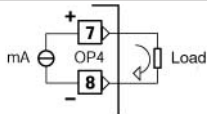

3.3.5 – E Double action relay/analogue mA control output

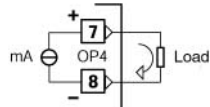
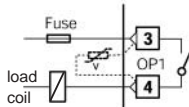

3.3.5 – F Double action relay/analogue mA control output

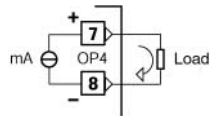
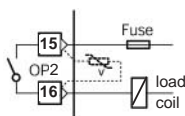

SX25 VMD Output combination



3.3.5 – G Valve Motor Drive Relay/Relay Control Output

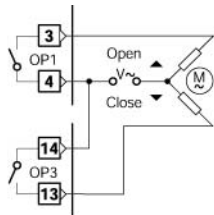

Valve drive PID without potentiometer (open,close,stop).

Relay output

- SPST Relay N.O., 2A/250 V~ for resistive load, fuse 2A ~ T

Logic output not isolated

- 0...5 V-, $\pm 20\%$, 30 mA max

3.3.5 – H Single Action Relay Control Output

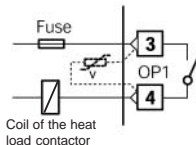

3.3.5 – J Double Action Relay/Relay Control Output

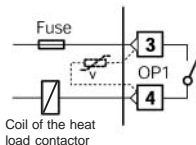

3.3.5 – I Single Action Logic Control Output

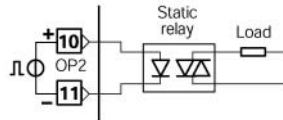

3.3.5 – K Double Action Relay/Logic Control Output

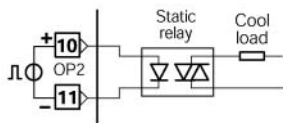
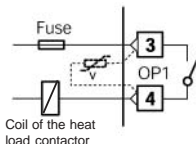

3.3.5 – L Double Action Logic/Relay Control Output

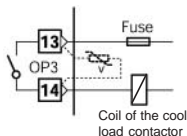
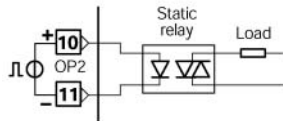

Relay output

- SPST Relay N.O., 2A/250 V~ for resistive load, fuse 2A ~ T

Logic output not isolated

- 0...5 V-, ±20%, 30 mA max

3.3.6 Alarms outputs

The outputs OP1, OP2 and OP3, can be used as alarm outputs only if they are not configured as control outputs.

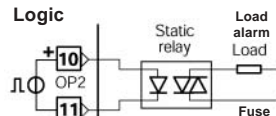
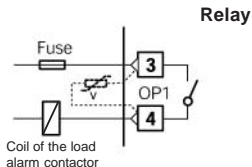

Relay

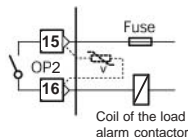

Relay

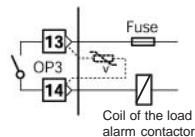

4. Configuration

4.1 Configuration coding

The configuration code consists of 4 digits that identify the operating characteristic of the controller, as chosen by the user.

Refer to section 5.6 configuration menu and section 6, commissioning examples for additional help.



The configuration code can be displayed on the front panel, following the instructions on page 22 section 5.2.2.

† 2.5Ω 1% shunt resistor must be fitted for mA input signal. See section 3.3.2

Input type and range			I
RTD Pt100 IEC 60751	-99.9...300.0 °C	-99.9...572.0 °F	0
RTD Pt100 IEC 60751	-200...600 °C	-328...1112 °F	1
TC L Fe-Const DIN43710	0...600 °C	-328...1112 °F	2
TC J Fe-Cu45% Ni IEC 60584	0...600 °C	32...1112 °F	3
TC T Cu-CuNi	-200...400 °C	-328...752 °F	4
TC K Chromel -Alumel IEC 60584	0...1200 °C	32...2192 °F	5
TC S Pt10%Rh-Pt IEC 60584	0...1600 °C	32...2912 °F	6
† 0...20mA/0...50 mV, linear	Engineering units		7
† 4...20mA/≈10...50 mV, linear	Engineering units		8
Custom input and range [1]			9

[1] For example, other thermocouples types, ΔT (with 2 PT 100), custom linearisation etc.

Control mode	SX25-VMD		SX25-mA		L
	Output configuration	Alarms	Output configuration	Alarms	
PID	Control OP1	OP2, OP3	Control OP4	OP2, OP3	0
	Control OP2	OP1, OP3	Control OP4	OP1, OP3	1
ON - OFF	Control OP1	OP2, OP3	Control OP4	OP2, OP3	2
	Control OP2	OP1, OP3	Control OP4	OP1, OP3	3
Heat/Cool Action	Control OP1-OP3	OP2	Control OP4-OP3	OP2	6
	Control OP1-OP2	OP3	Control OP4-OP2	OP3	7
	Control OP2-OP3	OP1	Control OP4-OP3	OP1	8
PID VMD	Control OP1-OP3	OP2	N/A	N/A	9

Control action type		M
Reverse (single action)	Linear Cool (Heat/Cool double action)	0
Direct (single action)	On-Off Cool (Heat/Cool double action)	1



When the controller is powered up for the first time, the display shows the following message.



This shows that the controller has not been configured.

Input the first code **ILMN**, using the up and down arrow keys, then press the enter key. The lower display will show **Con2**. Now input code **0** for alarm 3, then press enter.

The controller will remain in stand-by until the configuration code is set correctly (see section 5.6 page 36).

Alarm 2 type and function		N
Not active		0
Sensor break alarm/Loop Break Alarm		1
Process	active high	2
	active low	3
Deviation	active high	4
	active low	5
Band	active out	6
	active in	7

CON2

Alarm 3 type and function		O
Disabled		0
Sensor break alarm/Loop Break Alarm		1
Process	active high	2
	active low	3
Deviation	active high	4
	active low	5
Band	active out	6
	active in	7

For alarm type and function see page 30.

5. Operations

5.1 Keys and display overview

5.1.1 Key functions and display in operator mode

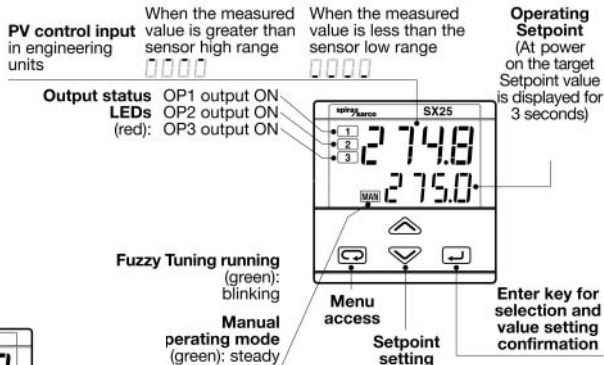

5.1.2 Key functions and display in programming mode

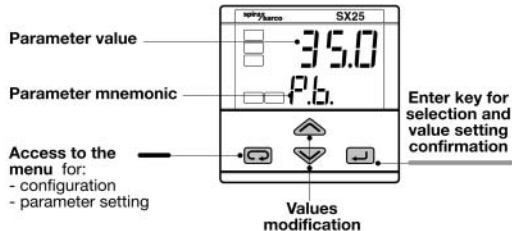

5.2 Display

During the operation, the parameters values cannot be modified by the user

5.2.1 Process variables

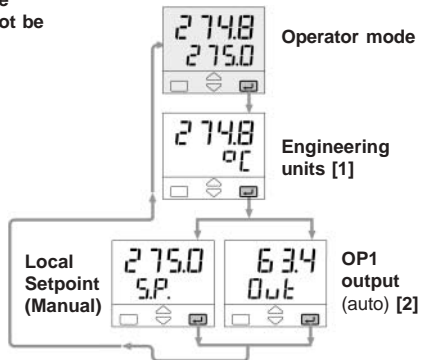

Note

[1] See table page 38

[2] This display is not shown if the instrument has been configured as an On - Off controller

5.2.2 Configuration codes

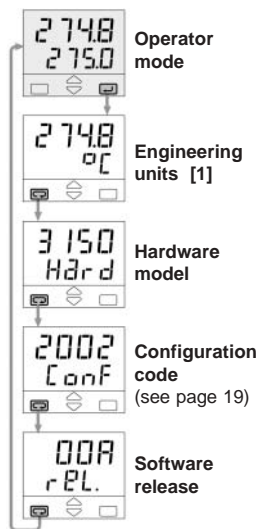



Example: 3150 - 2002 / Release 00A

5.3 Parameter setting

5.3.1 Numeric entry

(i.e. the modification of the Setpoint value from 275.0 to 240.0)

Press  or  momentarily to change the value of 1 unit every push.

Continued pressing of  or  changes the value, at a rate that doubles every second. Releasing the button causes the rate of change to decrease.

In any case the change of the value stops when it has reached the max/min limit set for the parameter.



In case of Setpoint modification:
press  or  once to display the local Setpoint instead of working Setpoint.

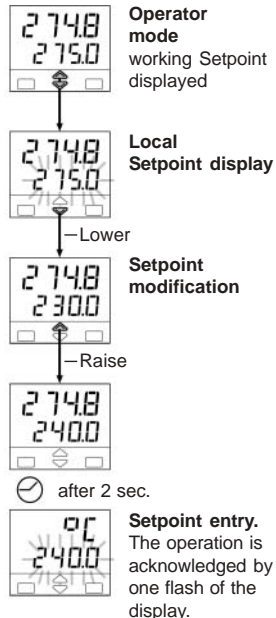

To confirm this change the display flashes once. Then the Setpoint can be modified



5.3.2 Mnemonic codes setting



(e.g. configuration see page 36)

Press the  or  to display the next or previous mnemonic for the selected parameter.

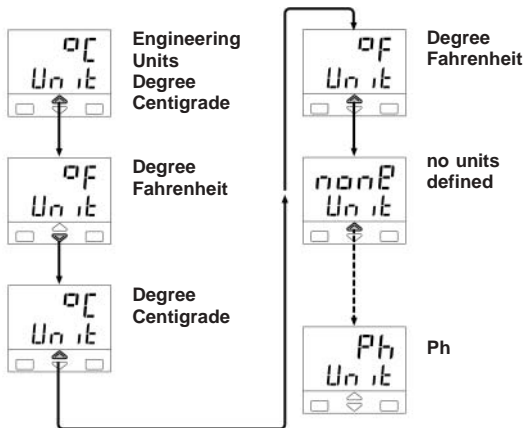
Continued pressing of  or  will display further mnemonics at a rate of one mnemonic every 0.5 sec.



5.3.3 Keypad lock

To lock/unlock the keypad press the keys  and  simultaneously for 2 seconds.

To confirm the keypad lock/unlock the display flashes once.

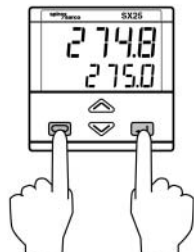



operator mode

Press
simultaneously
for 2 seconds

 The keypad lock is remembered during power failure.

5.3.4 Outputs lock

The outputs are switched to the OFF status by pressing the keys  and  together.

When the outputs are locked, the message  is displayed instead of the Setpoint value.

To unlock the outputs press both keys simultaneously (the Soft-start will be enabled).



 The outputs lock/unlock is remembered during power failure.

5.3.5 Auto / Man







Operator
mode



Select  to switch to manual mode



Select  to switch to automatic mode

- Press  to confirm. Back to operator mode.
- The  led shows the manual mode status.
- When manual mode is active, the Setpoint display shows the output value, that can be modified by  

5.4 Parameter menu

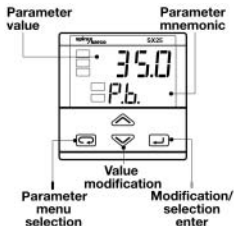

The parameter setting procedure has a timeout. If no key is pressed for 30 seconds, the controller automatically switches back to the operator mode.

After having selected the parameter or the code, press and to display or modify the value (see page 24). The value is entered when the next parameter is selected, by pressing the key.

Pressing the key, the next group of parameters will be displayed.

Note:

- [1] This will not be displayed if the controller has been configured with alarm 2 not active or if sensor break type selected. Digit N/M of the configuration code is assigned to 0 or 1.
- [2] Before *RdPt* is switched off, note down the calculated values. *P.b.*, *t. i.*, *t. d.* are not automatically stored.

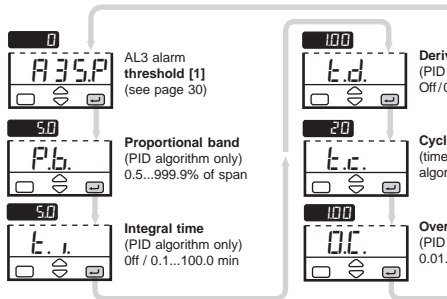
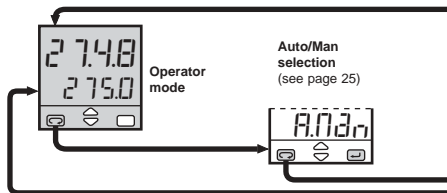

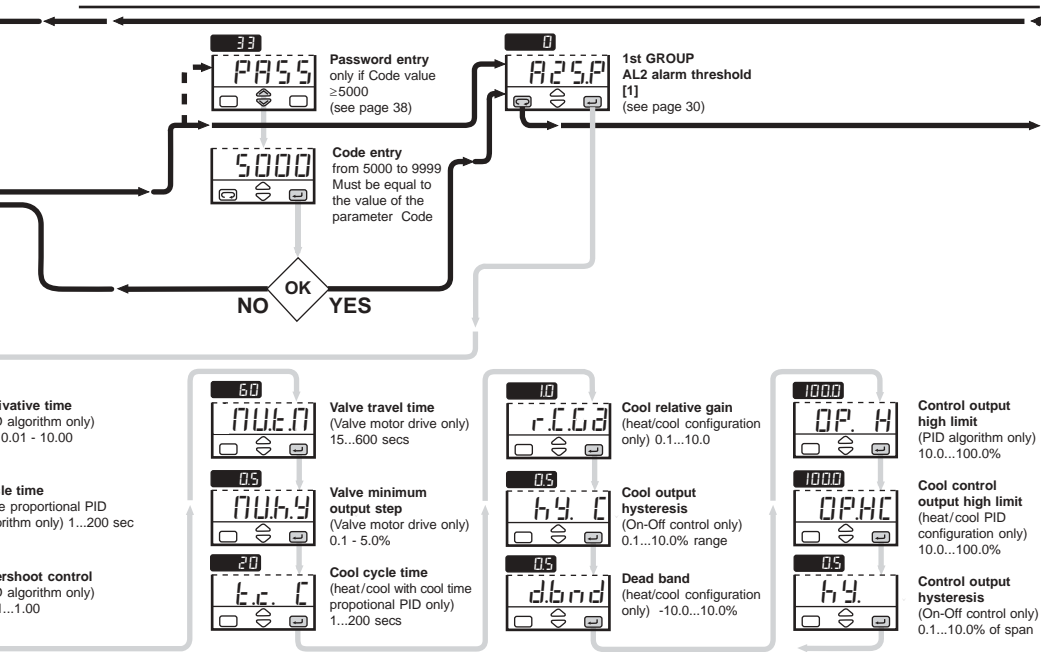

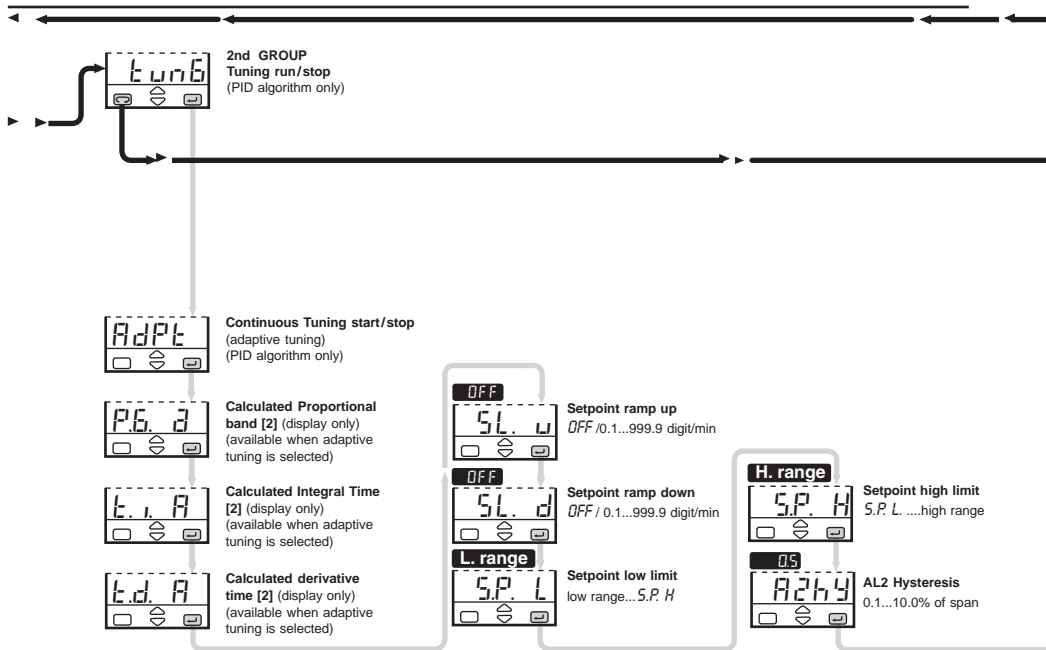



Password entry
only if Code value <5000
(see page 38).

Direct access
to the configuration
(pages 36 – 38)



AL2 latching and blocking functions
nonE / Ltch
bLoc / Ltbt



AL3 hysteresis
0.1...10.0% of span [1]



AL3 latching and blocking functions
nonE / Ltch
bLoc / Ltbt



LBA delay
(see page 32)
OFF = sensor break
1...9999 sec LBA



Time constant input filter
1...30 sec or *OFF*



Input shift
OFF / -60...60 digit



Error dead band
(PID algorithm only)
OFF / 0.1...10.0 digits



Soft-start output value
OFF / 0.1...100.0%



Soft-start activation time
(only if *StOP* different than *OFF*)
1...9999 sec.



Output safety value
0.0...100.0%
(-100.0...100.0% for heat/cool)

Back to the 2nd parameter group

5.5 Parameter description

First Group

The controller parameters have been organised in groups, according to their functionality.

A25.P

AL2 alarm threshold

A35.P

AL3 alarm threshold

The alarms use OP1, OP2 and OP3 outputs in different ways, according to the configured types of alarms, as illustrated.

With double action control output, (VMD or heating and cooling).

There is only one control output left. Alarm AL2 and AL3 will share the same output. (see table on page 14).

Sensor break or input disconnection



Absolute alarm

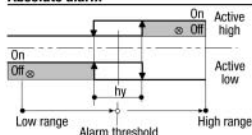

Deviation alarm

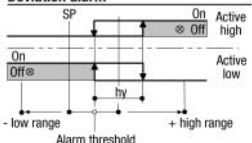

Band alarm

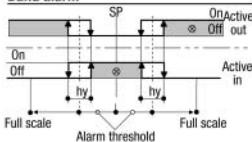

P.b

Proportional band

This parameter specifies the proportional band coefficient that multiplies the error (SP - PV)

t.i.

Integral time

The integral time value specifies the time required by the integral term to generate an output equivalent to the proportional term. When Off the integral term is not included in the control algorithm.

t.d.

Derivative time

The time required by the proportional term P to repeat the output provided by the derivative term D. When Off the derivative term is not included in the control algorithm.

t.c.

Control output cycle time

t.c. c

Cycle time cool

This is the cycle time of the logic control output.

O.C. **Overshoot control**

(Automatically disabled when the adaptive tuning is running). This parameter specifies the span of action of the overshoot control. The lower the O.C. value is, the smaller the overshoot will be during a set point change. The overshoot control doesn't affect the PID algorithm. If set to 1, the overshoot control is disabled.

d.bnd **Heat/Cool dead band**

This parameter specifies the width of the deadband between the Cool and the Heat channel.

NUt_n **Valve travel time**

NUh_y **Valve movement sensitivity**

OP.H **Control output high limit**

OP.HC **Cool output high limit**

This parameter specifies the maximum value the control output can be set

hy **Control output hysteresis**

hy.C **Cool output hysteresis**

Hysteresis of the threshold

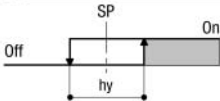

Control or alarm output hysteresis span, set in % of the full scale.

SL.u **Setpoint ramp up**

SL.d **Setpoint ramp down**

This parameter specifies the maximum rate of change of the Setpoint in digit / min. When the parameter is Off, this function is disabled.

R2hy **AL2 alarm hysteresis**

R3hy **AL3 alarm hysteresis**

Hysteresis of the threshold of both the alarms, that activate OP1 and OP2 control output. It is specified as a % of the full scale.

SP.L **Setpoint low limit**

SP.H **Setpoint high limit**

Low / high limit of the Setpoint value.

R2L.b **AL2, AL3 latching**

R3L.b **and blocking functions**

For each alarm it is possible to select the following functions

- nonP** none
- Ltch** latching
- bLoc** blocking
- Lt.bL** both latching and blocking

Second group

LtCh Latch Alarm

Using the latch function, the alarm will remain energised after the alarm condition is no longer present. To reset the latch, press any key and the alarm will switch off.

bLoc Start up disabling

Ramp down

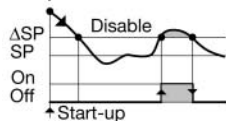

Ramp up

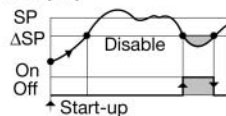

ΔSP Threshold = $SP \pm \text{range}$

Alarms with LBA (Loop Break Alarm) and Sensor Break Operation

The Loop Break Alarm will detect faults in the input and output circuit of the controller.

Select the code 1 on **N** or **O** configuration indexes (see page 20) to select the Loop Break Alarm. The following parameter is then available.

LbA LBA delay

This parameter will provide a time delay [1] of 1 to 9999 sec to the Loop Break Alarm

The alarm condition is indicated by the red alarm LED and the flashing display.

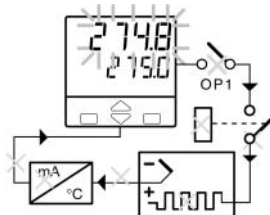

Loop Break Alarm Conditions

When the cause of the loop break disappears, the alarm status stops.

With the parameter set to OFF, the alarm will work with no delay.

The alarm condition is indicated by the red alarm LED and the upper display will show the following:

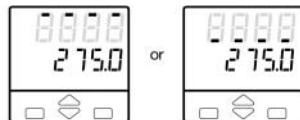

Note [1] If the input sensor breaks the alarm will energise immediately.

Second group

IFIL

Input filter time constant

This input filter provides a time constant (in seconds) to the PV input.

Filter response

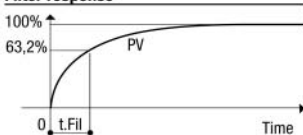

inSh

Input shift

The value entered into this parameter will offset the PV input value. Its effect is to shift the whole PV scale by ± 60 digits.

dErr

Error Dead Band

When the PV is within the error band, the control output will not change. This will help the life of the actuator by reducing the number of actuator starts.

STOP

Soft-start control output value

Set the value of the control output during the Soft-start activation time (in %). To de-activate the Soft-start, set to 'OFF'.

SttT

Soft-start activation time

Set the time duration (starting at power on) for the Soft-start function (in seconds).

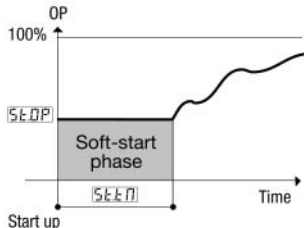

The Soft-start function is a warm up phase after the controller is first powered up.

The Soft-start will set the control value to a desired position (*STOP*) for the set duration (*SttT*).

SRDP

Output Safety value

If the input signal fails, the control value can be set to a safe position (in %).

Heat cool control

Using one PID control algorithm, the controller can handle two different outputs, one of these performs the Heat action, the other one the Cool action.

It is possible to overlap the outputs.

The dead band parameter \boxed{dbnd} is the zone where it is possible to separate or overlap the Heat and Cool actions.

The Cool action can be adjusted using the relative cool gain parameter $\boxed{r.c.gd}$.

To limit the Heat and Cool outputs the parameters Control Output High Limit $\boxed{OP.H}$ and Cool Control Output High Limit $\boxed{OP.HC}$ can be used.

When there is an overlap, the displayed output \boxed{OUE} shows the sum of the Heat and Cool outputs.

A Heat /Cool actions separated

Insert positive \boxed{dbnd} value
(0...10%)

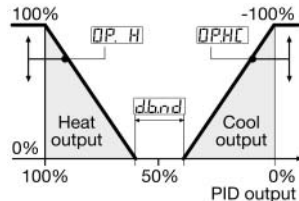

B Heat /Cool actions overlapped

Insert negative \boxed{dbnd} value
(-10...0%)

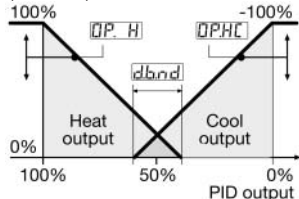

C Cool action adjusting

Example with different relative cool gains.

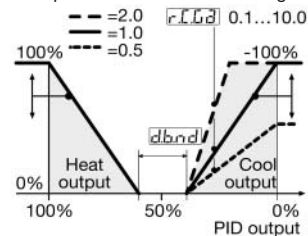

D On-Off Cool action

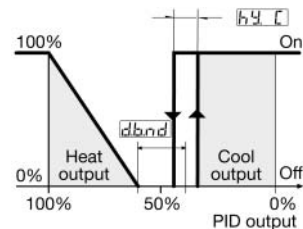

Analogue control output OP4

rPTr

Analogue control
output range

0-20 / 4-20

rE.H

Control output
selection

nonE

Not used

n.U.

Heat (single action)

n.U.C.

Cool

With **SX25** mA Cycle Time **Et**

or Cool Cycle Time **Et C**

are not present.

5.6 Configuration menu

The configuration of the controller is specified through a 4 digit code that defines the type of input, of control output and of the alarms. (section 4.1 page 19).

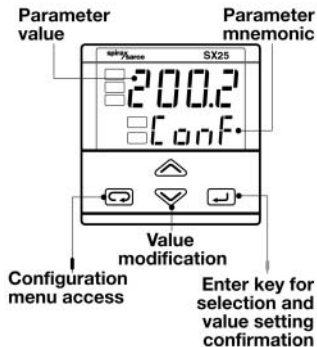

Press or to display the next parameter or the next code and change its value. The new value entered is stored into the controller when the next parameter is selected by pressing .

Pressing the will display the next group of parameters.

Note:
You must remember the password code. If the code is changed from 33, and the operator forgets the code, he will be locked out of the controller.

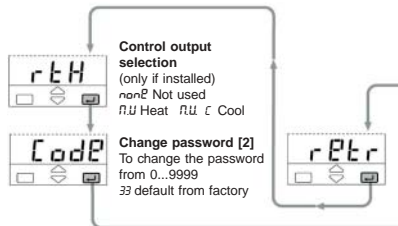
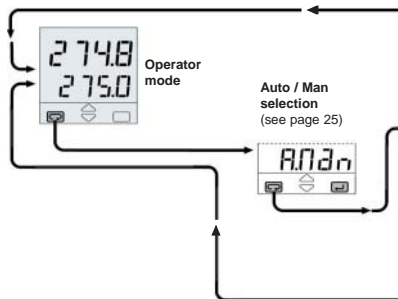

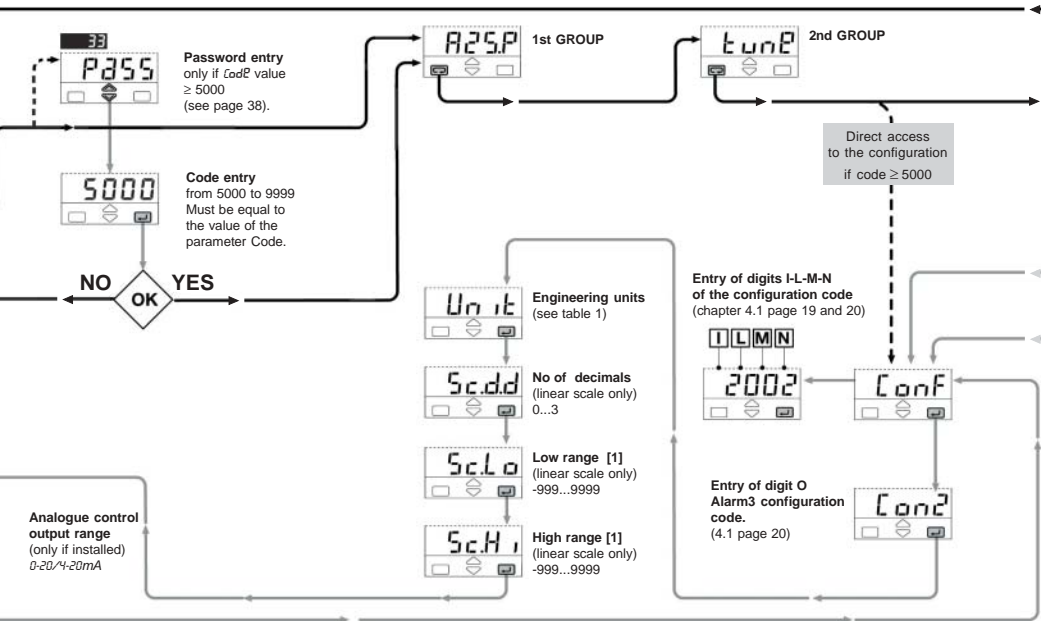

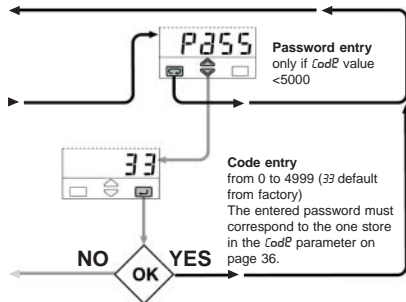

Direct access to the configuration

A From parameter menu, "PASS" (see page 29).

B At the first power on when the controller is not configured:

9999
Conf

In this situation, the controller has its outputs and inputs not active.
This situation ends when a correct configuration code is entered.

Table 1 -
Supported Engineering Units.

Centigrade degrees*	°C
Fahrenheit degrees*	°F
no units	none
mV	mV
Volt	V
mA	mA
Ampere	A
Bar	bar
PSI	PSI
Rh	rh
pH	pH

* For inputs from thermocouple or resistance thermometer, the choice is between °C and °F only.

Notes

- [1] Minimum Range 100 digits.
- [2] To hide the parameters, change the password to a number between 5000 to 9999.

6. Commissioning Examples

When the controller is first powered up the display will show:



This indicates that the controller is not configured (the controller will not function without being configured).

If on power up the display does not show the above, but instead the operator mode (process variable and set point) is shown it signifies that the controller has already been configured. If this is the case it is unlikely that the pre-set configuration will be suitable for your application.

To change the configuration code it is necessary to access the configuration menu. Section 5.6 shows how to access this menu.

To configure the controller a code number must be entered into the controller. The configuration code ILMNO, covers the input type, the control type, and the alarms.

Refer to Configuration Coding, in section 4.1 to select the desired configuration settings. Selected codes should be recorded in the customer configuration and parameter record sheet.

The following show examples of commissioning the SX25 controller providing guidance for similar applications.



6.1 Example of pressure control for SX25-mA

The SX25-mA controller is monitoring system pressure with a pressure transmitter, and provides a 4-20mA control signal to the control valve.

Configuration Code and parameters:

- Pressure transmitter 0 to 50 barg, producing a 4-20mA output signal.
- Control Valve with Electric or Electro-pneumatic positioner accepting a 4-20mA input signal.
- Two Event alarms are required. Event Y2 set for active high process alarm at 25 bar with the Latch function. Event Y3 set for active outside band alarm set at 5 bar.
- This process requires only one set point. The local set point is 20 bar

Configuration code

Using the  and  keys, enter the first part of the configuration code 'ILMN', conf.

I	L	M	N
8	0	0	2

Then press the enter key 

Enter the last digit for code 'O'
CON2.

0
4



Then press the enter key 

The configuration code is now entered, and the display will show:

0C
unit

This selects engineering units for the input signal. Using the table below enter the following values into these parameters.

Parameter	Description	Default Value	New Value
Unit	Input Eng. units	C	bar
Sc.d.d	Number of decimals	0	1
Sc.Lo	Low input value	-999.9	0.0
Sc.Hi	High input value	999	50.0
rert	Analogue output range	4 - 20 mA	4 - 20 mA
rth	Output Heating/Cooling	nu	nu
Code	Change Security code	33	33

Press the enter key  to review the data you have entered or press the scroll key  to exit the configuration menu.

First group parameters

Press the scroll key 

The display will show



Auto
MAN

which provides the option of selecting Automatic or manual control.

Press the scroll key  again.

The display will show





A2S.P

 Alarm 2 threshold value.

Using the table opposite, enter the following values into the parameters.

Parameter	Description	Default Value	Customer set Values
A2S.P	Alarm 2 set point	Stop	Stop
A3S.P	Alarm 3 set point	Stop	Stop
P.b.	Proportional band	5.0	5.0
t.i.	Integral time	5.0	5.0
t.d.	Derivative time	1.00	1.00
O.C.	Overshoot Control	1.00	1.00
nu.tn	Valve travel time	60	40
nu.hy	Valve Minimum output step	0.5	.05
OP.H	Control output high limit	100.0	5.0

Press the enter key  to save the value entered and to move to the next parameter.

When the last parameter has been entered, press the enter key  to save this value.

Now press the scroll key  to edit the second group parameters.

Second group parameters

The display will show

STOP
tune

This is used to start the automatic tuning. Using this table enter the following values into these parameters.



Press the enter key  to save the value entered and to move to the next parameter.

When the last parameter has been entered, press the enter key  to save this value.

To exit press the scroll key .

The display will show: 

Press the scroll key  again and the display will return to the normal operating mode.

The controller is ready to operate. Now enter the required set point of 20.0 bar by using the  and  keys.

Parameter	Description	Default Value	Customer set Values
tune	Tuning PID	Stop	Stop
AdPt	Adaptive tuning PID	Stop	Stop
SL. u	Set point ramp up	Off	Off
SL. d	Set point ramp down	Off	Off
S.P. L	Set point low limit	0.0	0.0
S.P. H	Set point high limit	50.0	25.0
A2hy	Alarm 2 hysteresis	0.5	0.5
A2L.b	Alarm 2 latching and blocking	none	Ltch
A3hy	Alarm 3 hysteresis	0.5	0.5
A3L.b	Alarm 3 latching and blocking	none	none
t.F iL	Time constant input filter	Off	Off
In.Sh	Input shift	Off	Off
d.Err	Error dead band	Off	Off
St.OP	Soft start output value	Off	Off
Sa.OP	Control output high limit	0.0	0.0

To improve control of the application, adjust the proportional band and integral time accordingly.



6.2 Example of temperature control for SX25-VMD

The SX25-VMD controller is monitoring system temperature with a RTD Pt100, and provides a Valve Motor Drive control signal to the electric control valve.

Configuration Code and parameters:

- Temperature sensor with an effective range from 0°C to 100°C.
- Control Valve with 20mm stroke and Valve Motor Drive electric actuator, speed 0.5mm/s .
- Two Event alarms are required. Event Y2 set for active low process alarm set at 35°C with the blocking function. Event Y3 set for an active high deviation alarm set at 10°C.
- The process temperature required is 60°C is the control temperature.

Configuration code

Using the  and  keys, enter the first part of the configuration code 'ILMN'.

I	L	M	N
8	0	0	2

then press the enter key 

Enter the last digit for code 'O'

O
4

then press the enter key 

The configuration code is now entered, and the display will show:

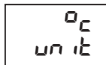

This selects Celsius or Fahrenheit for the temperature units.

Using the table below enter the following values into the parameters.

Parameter	Description	Default Value	New Value
Unit	temperature units	°C	°C
Code	Change Security code	33	33

Press the enter key  to save the value entered and to move to the next parameter.

When the configuration menu is exited, the display will now show the normal operating mode, with the process variable at the top and the set point at the bottom.

For example:



With the controller configured, the parameters can now be entered.

First group parameters

From the normal operating mode press the scroll key . The display will show



The display shows two options: "Auto" and "MAN".

which provides the option of selecting Automatic or manual control.

Press the scroll key  again.

The display will show  Alarm2 set point. Using the table opposite, enter the following values into the parameters.

Press the enter key  to save the value entered and to move to the next parameter.

Parameter	Description	Default Value	Customer set Values
A2S.P	Alarm 2 set point	0.0	35.0
A3S.P	Alarm 3 set point	0.0	10.0
P.b.	Proportional band	5.0	5.0
t.i.	Integral time	5.0	5.0
t.d.	Derivative time	1.00	1.00
O.C.	Overshoot Control	1.00	1.00
nu.tn	Valve travel time	60	40
nu.hy	Valve Minimum output step	0.5	.05
OP.H	Control output high limit	100.0	5.0

When the last parameter has been entered, press the enter key  to save this value.

Now press the scroll key .

Second group parameters

The display will show

STOP
tune

This is used to start the automatic tuning. Using the table opposite, enter the following values into these parameters.

Press the enter key  to save the value entered and to move to the next parameter.



When the last parameter has been entered, press the enter key  to save this value.

Press the scroll key .

The display will show: **PASS**

Press the scroll key  again and the display will return to the normal operating mode.

Parameter	Description	Default Value	New Values
tune	Tuning PID	Stop	Stop
AdPt	Adaptive tuning PID	Stop	Stop
SL. u	Set point ramp up	Off	Off
SL. d	Set point ramp down	Off	Off
S.P. L	Set point low limit	-99.9	5.0
S.P. H	Set point high limit	300.0	80.0
A2hy	Alarm 2 hysteresis	0.5	0.5
A2L.b	Alarm 2 latching and blocking	none	bloc
A3hy	Alarm 3 hysteresis	0.5	0.5
A3L.b	Alarm 3 latching and blocking	none	none
t.F iL	Time constant input filter	Off	Off
In.Sh	Input shift	Off	Off
d.Err	Error dead band	Off	Off
St.OP	Soft-start output value	Off	Off
Sa.OP	Output safety value	0.0	0.0

The controller is ready to operate. Now enter the required set point of 60°C by using the  and  keys. And read section 5 (Automatic tuning), for the self-setting of the PID values.

7. Automatic tuning

Two tuning methods are provided:

- Initial one shot **Fuzzy-tuning**
- Continuous, self learning **Adaptive Tuning**

Fuzzy-Tuning allows the calculation of the optimal PID parameters by monitoring the response of the process.

The controller provides 2 types of tuning algorithms, that are selected automatically according to the process condition when the operation is started.

Step response

This type is selected when the process is started.

There must be a difference between the set point and the PV of more than 5% of the input scan.

This method has the big advantage of fast calculation, with a reasonable accuracy in the PID calculation.

Natural frequency

This is selected when the Process Variable (PV) is close to the Setpoint (SP).

This method provides a more accurate PID calculation but will take more time to complete.

If the natural frequency tune is taking too long to complete, try the step response time.

Step response

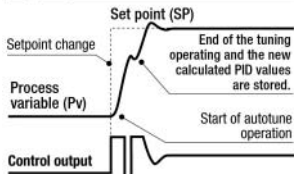

Natural frequency

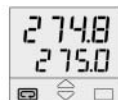
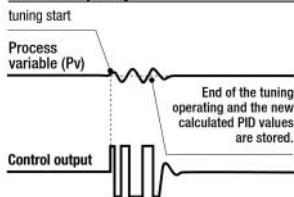

Operator mode



press until

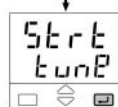

To start select **StPt**



To stop select **StoP**

The green led  will flash when the Fuzzy Tuning is in operation. At the end of this operation, the calculated PID values are stored and used by the control algorithm and the controller automatically returns to the operator mode. The green led  will switch off.

The self-learning Adaptive Tuning is non-intrusive. It doesn't affect the process during the calculation of the optimal PID values.

Continuous Adaptive Tuning

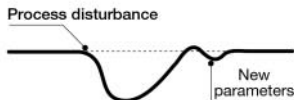

It is particularly suitable for controlling process whose control characteristics change with time or are not linear in relation to the Setpoint values. It doesn't require any operation by the user. It works by continuously sampling the process response to the various process disturbance, determining the frequency and the amplitude of the signals.

On the basis of this data and their statistical values, stored in the instrument, it automatically modifies the PID values.

The new calculated PID values are stored in the controller's menu, under Adaptive Selection (see page 28).

Note:
Before the Adaptive is switched off, note down the calculated PID values.

If the Adaptive is switched off the new PID values will be lost

If the power fails during Adaptive Tuning, the PID values are lost. At power on, the Adaptive Tuning starts automatically and will re-calculate the PID values.

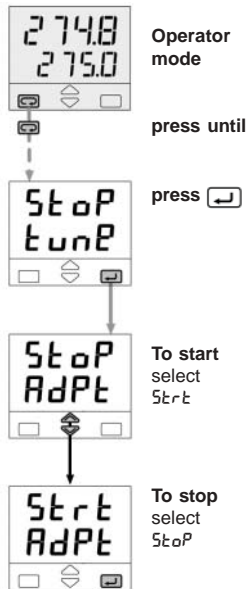

8. Technical specifications

Features (at 25°C environmental temp.)	Description			
Total configurability (see section 4.1 page 19 section 5.6 page 36)	From the keypad the user can select: - type of input - type of control algorithm - type and functionality of the alarms - associated functions and the corresponding outputs - type of output and the safe conditions - values of all the control parameters.			
PV Input (see page 12, 13 and 19)	Common characteristics	A/D converter with resolution of 50.000 points Update measurement time: 0.2 seconds Sampling time: 0.5 seconds Input bias: - 60...+ 60 digit Input filter with enable/disable: 1...30 seconds		
	Accuracy	0.25% ± 1 digits for temperature sensors 0.1% ± 1 digit for mV 1.25% ± 1 digits for mA 1.25% ± 1 digit for mA	Between 100...240V – the error is minimal	
	Resistance thermometer (for ΔT: R1+R2 must be <320Ω)	Pt100Ω at 0°C/32°F (IEC 60751) °C/°F selectable	2 or 3 wires connection Burnout (with any combination)	Max. wire Res: 20Ω max (3 wires) Input drift 0.35°C/10° Env. Temp. <0.35°C/10Ω Wire Res.
	Thermocouple	L,J,T,K,S (IEC 60584) Rj >10MΩ °C/°F selectable	Internal cold junction compensation con NTC Error 1°C/20°C ±0.5°C Burnout	Line: 150Ω max Input drift: <2μV/°C Env. Temp <5μV / 10Ω Wire Res.
	DC input (current)	4...20mA, 0-20mA with external shunt 2.5Ω 1% Rj >10MΩ	Engineering units Conf. decimal point position Init. Sc -999...9999 Full Sc. -999...9999 (min. range of 100 digits)	Input drift: <0.1% / 20°C Env. Temp. <0.5μV / 10Ω Wire Res.
	DC input (voltage)	10...50mV, 0-50mV Rj >10MΩ		

Features (at 25°C environmental temp.)	Description						
Operating modes and outputs	1 double action PID loop or On/Off with 1 or 2 alarms	Single action	Control output		AL2 alarm	AL3 alarm	
			OP1-Relay /Triac		OP2-Relay or logic	OP3-Relay/Triac	
			OP2 -Logic		OP1-Relay /Triac	OP3-Relay/Triac	
		Double action Heat/cool	OP1-Relay /Triac	OP3-Relay /Triac	OP2-Relay or logic		
			OP1-Relay /Triac	OP2 Logic			OP3-Relay/Triac
			OP2 Logic	OP3-Relay /Triac	OP1-Relay /Triac		
Control mode	Algorithm		PID with overshoot control or On-off				
	Proportional band (P)		0.5...999.9%		PID algorithm		
	Integral time (I)		0.1...100.0 min				
	Derivative time (D)		0.01...10.00 min				
	Error band		0.1...10.0 digit				
	Cycle time		1...200 sec				
	Dead band		-10.0...10.0%		Heat / cool control action		
	Cool relative gain		0.1...0.10				
	Cool cycle time		1...200 sec				
	Overshoot control		0.01...1.00		PID algorithm		
	High limit		100.0...10.0% (heat) -100.0...-10.0%(cool)				
	Hysteresis		0.1...10.0%		On-Off algorithm		

Features (at 25°C environmental temp.)	Description			
OP1 output	SPST Relay N.O., 2A/250V~ for resistive load Triac, 1A/250V~ for resistive load		Protection by varistor for 220V ~ and capacitor	
OP2 output	Logic not isolated: 5V~, ± 10%, 30mA max SPST Relay N.O., 2A/250V~ for resistive load	Jumper selectable (page 13)		
OP3 output	SPST Relay N.O., 2A/250V~ for resistive load Triac, 1A/250V~ for resistive load			
OP4 countinuous control output (option)	Galvanic isolation: 500 V~/1 min Resolution 12bit (0.025%) Accuracy: 0.1 %	In current: 0/4...20mA 750%/15V max		
AL2 - AL3 alarms	Hysteresis 0.1...10.0% c.s.			
	Action	Active high	Action type	Deviation threshold ±range
		Active low		Band threshold 0...range
		Sensor break, heater break alarm, Latching/Blocking, Loop Break Alarm		Absolute threshold whole range
Setpoint	Ramp up and down. User inhibited.		0.1...999.9 digit/min	
	Low limit		from low range to high limit	
	High limit		from low limit to high range	
Tuning	Fuzzy-Tuning The controller selects automatically the best method according to the process conditions		Step response	
	Adaptive Tuning self-learning, not intrusive, analysis of the process response to perturbations and continuously calculation of the PID parameters		Natural frequency	
Auto/Man station	Standard with bumpless function			
Auxillary supply	+18V- ±20%, 30mA max. for external transmitter supply			

Features (at 25°C environmental temp.)	Description	
Operational safety	Measure input	Detection of out of range, short circuit or sensor break with automatic activation of the safety strategies and alerts on display
	Control output	Safety value: -100%...100%
	Parameters	Parameter and configuration data are stored in a non volatile memory for an unlimited time
	Access protection	Password to access the configuration and parameters data, keypad lock, output lock
General characteristics	Power supply (PTC protected)	100 - 240V~ (- 15% + 10%) 50/60 Hz or 24V~ (- 25% + 12%), 50/60 Hz and 24V~ (- 15% + 25%) Power consumption 2.6 W max.
	Safety	Compliance to EN 61010-1 (IEC 601010 – 1), installation class 2 (2500V) pollution class 2, instrument class II
	Electromagnetic compatibility	Compliance to the CE standards (see page 5)
	Protection EN60529 (IEC 529)	IP65 front panel
	Dimensions	1/16 DIN - 48 x 48, depth 120 mm, weight 130 gr. apx. 1.89 x 1.89, depth 4.72 in, weight 4.6 oz. apx.